



# History of

$\mu$ SR *rotation  
relaxation  
resonance*

*m*  
*u*  
*o*  
*n*      *s*  
*p*  
*i*  
*n*

Applied\*  
Elementary  
Particle  
Physics

*A science fiction adventure story*

*by*

*Jess H. Brewer*



# History of

$\mu$ SR *rotation  
relaxation  
resonance*

*m  
u  
o  
n*

*s  
p  
i  
n*

Applied\*  
Elementary  
Particle  
Physics

\* (to basic research in  
Materials Science  
and Chemistry)

# OUTLINE

- **Early History** of  $\mu SR$  (“*science fiction*”?)
- Research “**Themes**” in  $\mu SR$
- Development of **Advanced Muon Beams**
- $\mu SR$  **techniques** (*green: not* invented at TRIUMF)
  - acronyms: *wTF*, ZF, *LF*, *Strobo*, *FFT*,  
SR, HTF, RRF, ALCR, *RF*,  $\mu SI$ , E-field
- ( $\mu SR$  **applications** interleaved among **techniques...**)

# Evolution of $\mu SR$ :

Fantasy  $\rightarrow$  Fiction  $\rightarrow$  Physics

# Evolution of $\mu SR$ :

**Fantasy** → **Fiction** → **Physics**

- **Fantasy**: violates the “known laws of physics”

# Evolution of $\mu SR$ :

Fantasy → Fiction → Physics

- **Fantasy**: violates the “known laws of physics”
- **Science Fiction**: possible in principle, but impractical with existing technology. (**Clarke’s Law**: *“Any sufficiently advanced technology is indistinguishable from magic.”*)

# Evolution of $\mu SR$ :

**Fantasy** → **Fiction** → **Physics**

- **Fantasy**: violates the “known laws of physics”
- **Science Fiction**: possible in principle, but impractical with existing technology. (**Clarke’s Law**: “Any sufficiently advanced technology is indistinguishable from magic.”)
- **Routine Physics**: “We can do that . . .”

# Evolution of $\mu SR$ :

**Fantasy** → **Fiction** → **Physics**

- **Fantasy**: violates the “known laws of physics”
- **Science Fiction**: possible in principle, but impractical with existing technology. (**Clarke’s Law**: “Any sufficiently advanced technology is indistinguishable from magic.”)
- **Routine Physics**: “We can do that . . .”
- **Applied Science**: “. . . and so can you!”



# Before 1956: $\mu SR = Fantasy$

(violates “known laws of physics”)

- 1930s: **Mistaken Identity**

Yukawa’s “nuclear glue” **mesons**  $\neq$  **cosmic rays**

1937 Rabi: Nuclear Magnetic Resonance

- 1940s: **“Who Ordered That?”**

1944 Rasetti: 1<sup>st</sup> application of muons to condensed matter physics

1946 Bloch: Nuclear Induction (modern NMR with FID *etc.*)

1946 Various: “two-meson”  $\pi$ - $\mu$  hypothesis

1947 Richardson: produced  $\pi$  &  $\mu$  at Berkeley 184 in. Cyclotron

1949 Kuhn: *“The Structure of Scientific Revolutions”*

# THE PHYSICAL REVIEW

*A journal of experimental and theoretical physics established by E. L. Nichols in 1893*

SECOND SERIES, VOL. 66, Nos. 1 AND 2

JULY 1 AND 15, 1944

## Deflection of Mesons in Magnetized Iron

F. RASETTI

*Laval University, Quebec, Canada*

(Received May 8, 1944)

The deflection of mesons in a magnetized ferromagnetic medium was investigated. A beam of mesons was made to pass through 9 cm of iron, and the resulting distribution of the beam was observed. Two arrangements were employed. In the first arrangement, the deflection due to the field caused a fraction of the mesons to hit a counter placed out of line with the others. An increase of sixty percent in the number of coincidences was recorded when the iron was magnetized. In the second arrangement, all the counters were arranged in line, and the deflection due to the field caused an eight percent decrease in the number of coincidences. These results are compared with theoretical predictions deduced from the known momentum spectrum of the mesons and from the geometry of the arrangement. The observed effects agree as well as can be expected with those calculated under the assumptions that the effective vector inside the ferromagnetic medium is the induction  $B$ , and that the number of low energy mesons is correctly given by the range-momentum relation.

# Before 1956: $\mu SR = Fantasy$

(violates “known laws of physics”)

- 1930s: **Mistaken Identity**

Yukawa’s “nuclear glue” **mesons**  $\neq$  **cosmic rays**

1937 Rabi: Nuclear Magnetic Resonance

- 1940s: **“Who Ordered That?”**

1944 Rasetti: 1<sup>st</sup> application of muons to condensed matter physics

1946 Bloch: Nuclear Induction (modern NMR with FID *etc.*)

1946 Various: “two-meson”  $\pi$ - $\mu$  hypothesis

1947 Richardson: produced  $\pi$  &  $\mu$  at Berkeley 184 in. Cyclotron

1949 Kuhn: *“The Structure of Scientific Revolutions”*

# Before 1956: $\mu SR = Fantasy$

(violates “known laws of physics”)

- 1930s: **Mistaken Identity**

Yukawa’s “nuclear glue” **mesons**  $\neq$  **cosmic rays**

1937 Rabi: Nuclear Magnetic Resonance

- 1940s: **“Who Ordered That?”**

1944 Rasetti: 1<sup>st</sup> application of muons to condensed matter physics

1946 Bloch: Nuclear Induction (modern NMR with FID *etc.*)

1946 Various: “two-meson”  $\pi$ - $\mu$  hypothesis ***Brewer: born***

1947 Richardson: produced  $\pi$  &  $\mu$  at Berkeley 184 in. Cyclotron

1949 Kuhn: *“The Structure of Scientific Revolutions”*

# 1956-7: *Revolution*

- **1950s: “Particle Paradise”**  
 culminating in weird results with strange particles:  
**1956 Cronin, Fitch, . . .** : “ $\tau - \theta$  puzzle” (neutral **kaons**)
- **1956: Lee & Yang** postulate  
 **$P$ -violation** in weak interactions
- **1957: Wu** confirms  $P$ -violation in  $\beta$  decay;  
**Friedman & Telegdi** confirm  $P$ -violation in  $\pi$ - $\mu$ -e decay;  
 so do **Garwin, Lederman & Weinrich**,  
 using a prototype  **$\mu SR$**  technique.

PHYSICAL REVIEW

VOLUME 104, NUMBER 1

OCTOBER 1, 1956

## Question of Parity Conservation in Weak Interactions\*

T. D. LEE, *Columbia University, New York, New York*

AND

C. N. YANG, † *Brookhaven National Laboratory, Upton, New York*

(Received June 22, 1956)

The question of parity conservation in  $\beta$  decays and in hyperon and meson decays is examined. Possible experiments are suggested which might test parity conservation in these interactions.



## Experimental Test of Parity Conservation in Beta Decay\*

C. S. WU, *Columbia University, New York, New York*

AND

E. AMBLER, R. W. HAYWARD, D. D. HOPPES, AND R. P. HUDSON,  
*National Bureau of Standards, Washington, D. C.*

(Received January 15, 1957)

# Observations of the Failure of Conservation of Parity and Charge Conjugation in Meson Decays: the Magnetic Moment of the Free Muon\*

RICHARD L. GARWIN,† LEON M. LEDERMAN,  
AND MARCEL WEINRICH

*Physics Department, Nevis Cyclotron Laboratories,  
Columbia University, Irvington-on-Hudson,  
New York, New York*

(Received January 15, 1957)

# Nuclear Emulsion Evidence for Parity Nonconservation in the Decay Chain

$$\pi^+ \rightarrow \mu^+ + e^+ + \nu$$

JEROME I. FRIEDMAN AND V. L. TELEGDI

*Enrico Fermi Institute for Nuclear Studies, University of Chicago,  
Chicago, Illinois*

(Received January 17, 1957)

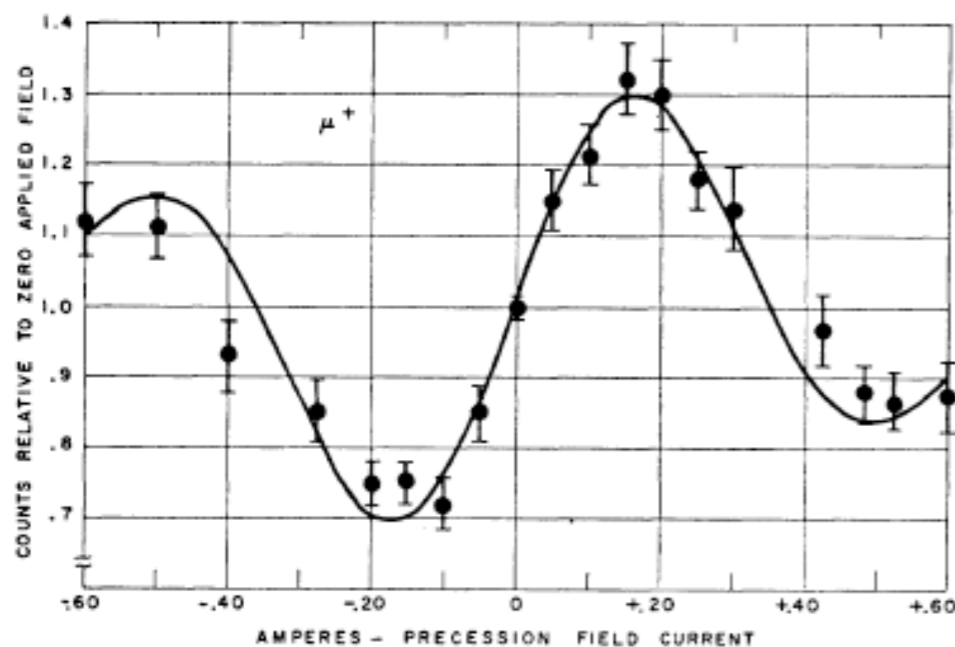

FIG. 2. Variation of gated 3-4 counting rate with magnetizing current. The solid curve is computed from an assumed electron angular distribution  $1 - \frac{1}{3} \cos\theta$ , with counter and gate-width resolution folded in.

It seems possible that polarized positive and negative muons will become a powerful tool for exploring magnetic fields in nuclei (even in Pb, 2% of the  $\mu^-$  decay into electrons<sup>9</sup>), atoms, and interatomic regions.

*For newcomers . . .*

*How does it work?*

*. . . a brief introduction to*





# Pion Decay: $\pi^+ \rightarrow \mu^+ + \nu_\mu$

A spinless *pion* **stops** in the “skin” of the primary production target. It has zero linear momentum and zero angular momentum.

**Conservation of Linear Momentum:** The  $\mu^+$  is emitted with momentum equal and opposite to that of the  $\nu_\mu$ .

**Conservation of Angular Momentum:**  $\mu^+$  &  $\nu_\mu$  have equal & opposite spin.

## Weak Interaction:

Only “left-handed”  $\nu_\mu$  are created.

Thus the emerging  $\mu^+$  has its spin pointing antiparallel to its momentum direction.

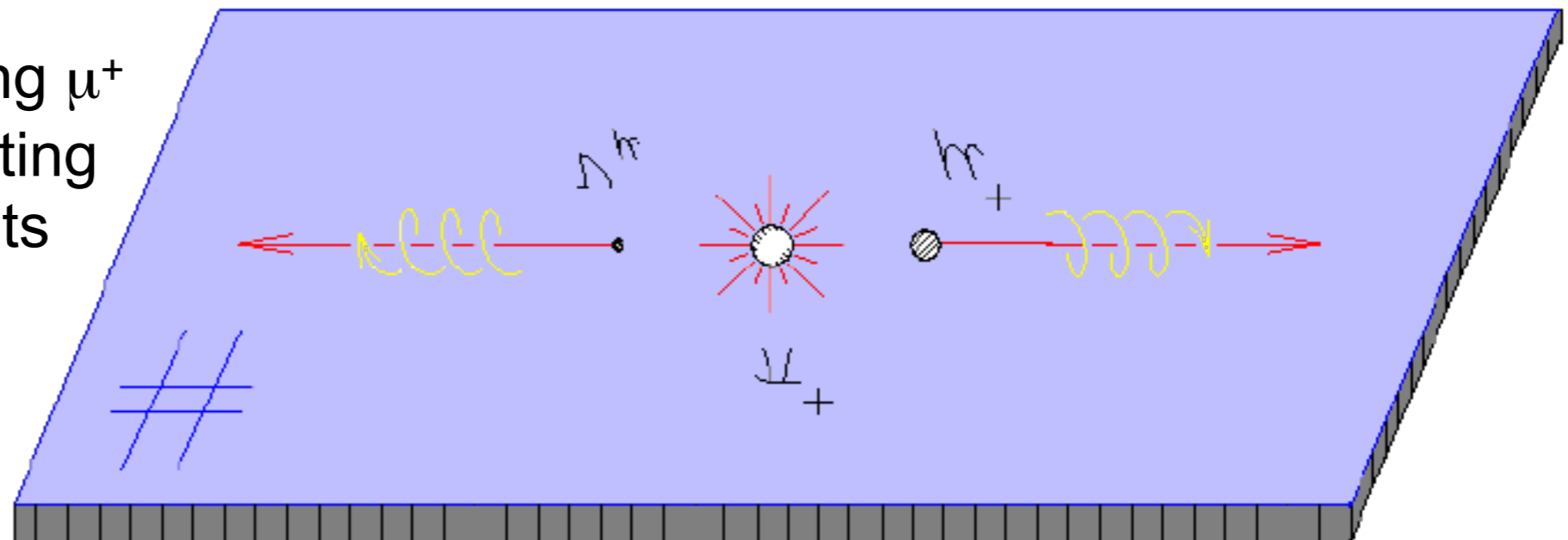
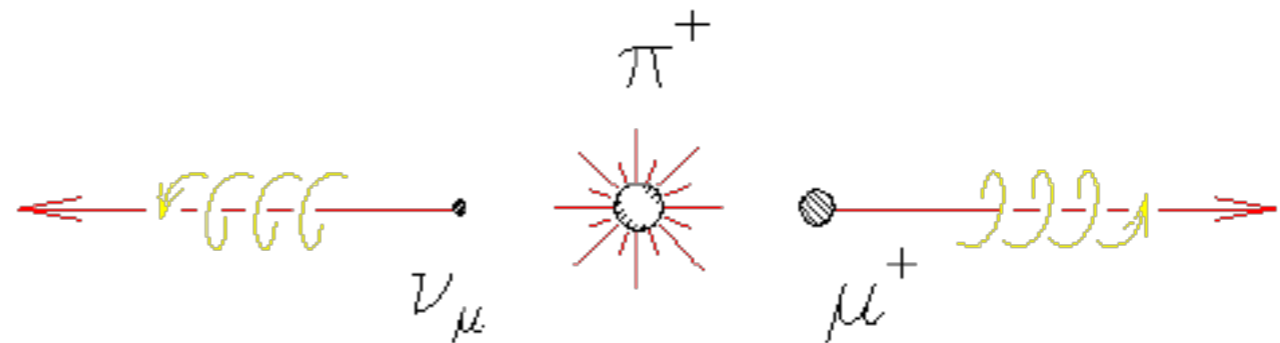

# Pion Decay: $\pi^+ \rightarrow \mu^+ + \nu_\mu$

A spinless *pion* **stops** in the “skin” of the primary production target. It has zero linear momentum and zero angular momentum.

**Conservation of Linear Momentum:** The  $\mu^+$  is emitted with momentum equal and opposite to that of the  $\nu_\mu$ .

**Conservation of Angular Momentum:**  $\mu^+$  &  $\nu_\mu$  have equal & opposite spin.

## Weak Interaction:

Only “left-handed”  $\nu_\mu$  are created.

Thus the emerging  $\mu^+$  has its spin pointing antiparallel to its momentum direction.

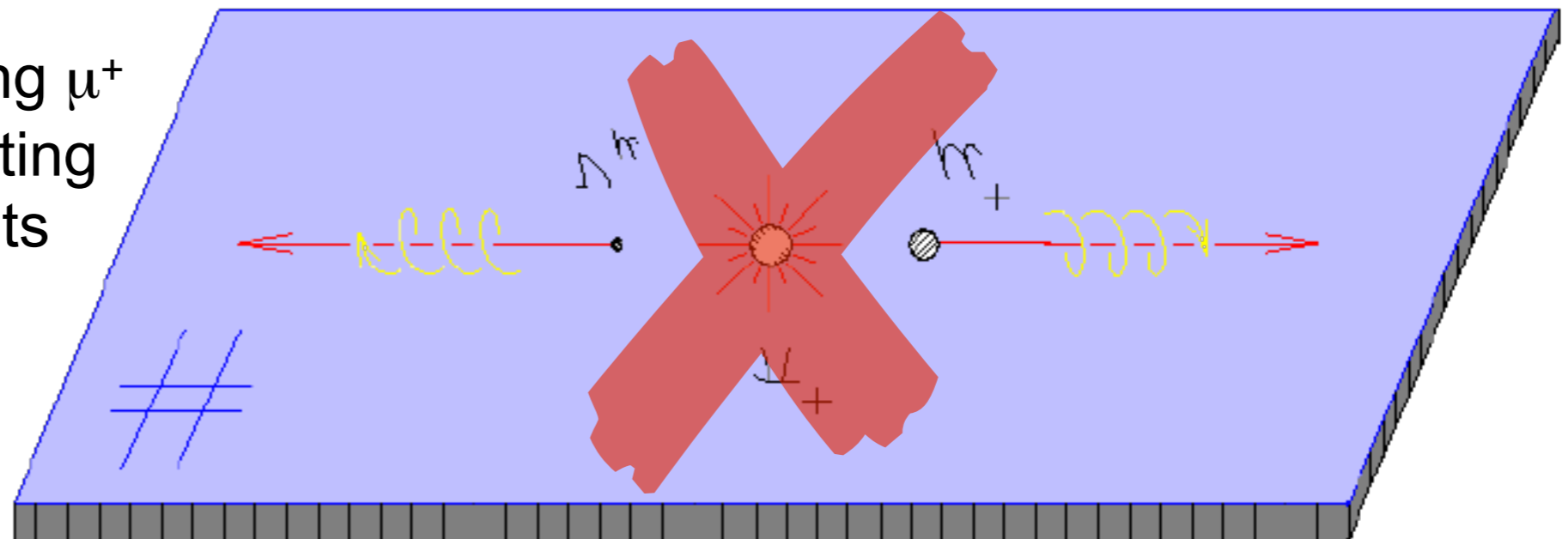
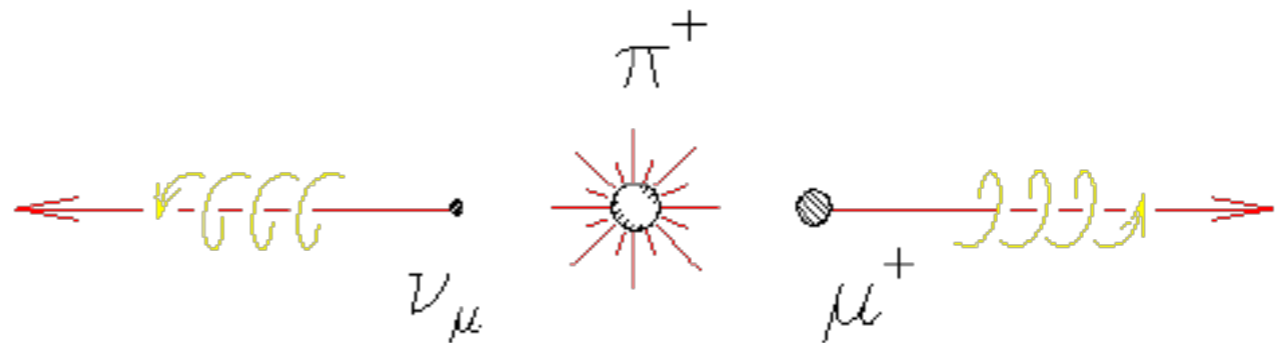

# $\mu^+$ Decay

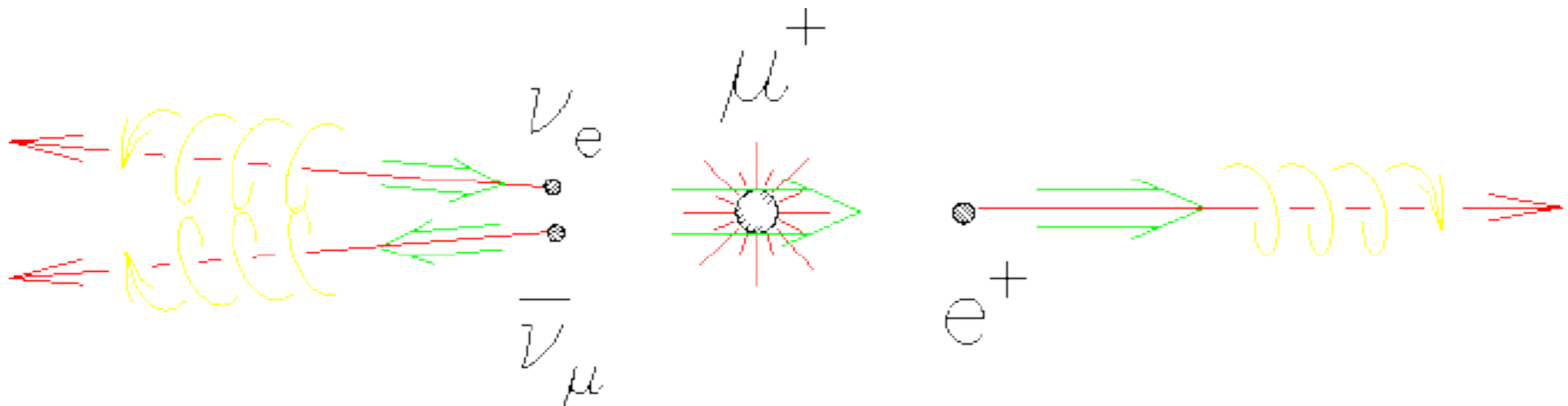

Neutrinos have negative helicity, antineutrinos positive.  
 An ultrarelativistic positron behaves like an antineutrino.  
 Thus the positron tends to be emitted along the  $\mu^+$  spin  
 when  $\nu_e$  and  $\bar{\nu}_\mu$  go off together (highest energy  $e^+$ ).

# Weak Transverse Field

## (wTF)- $\mu^+$ SR (CW)

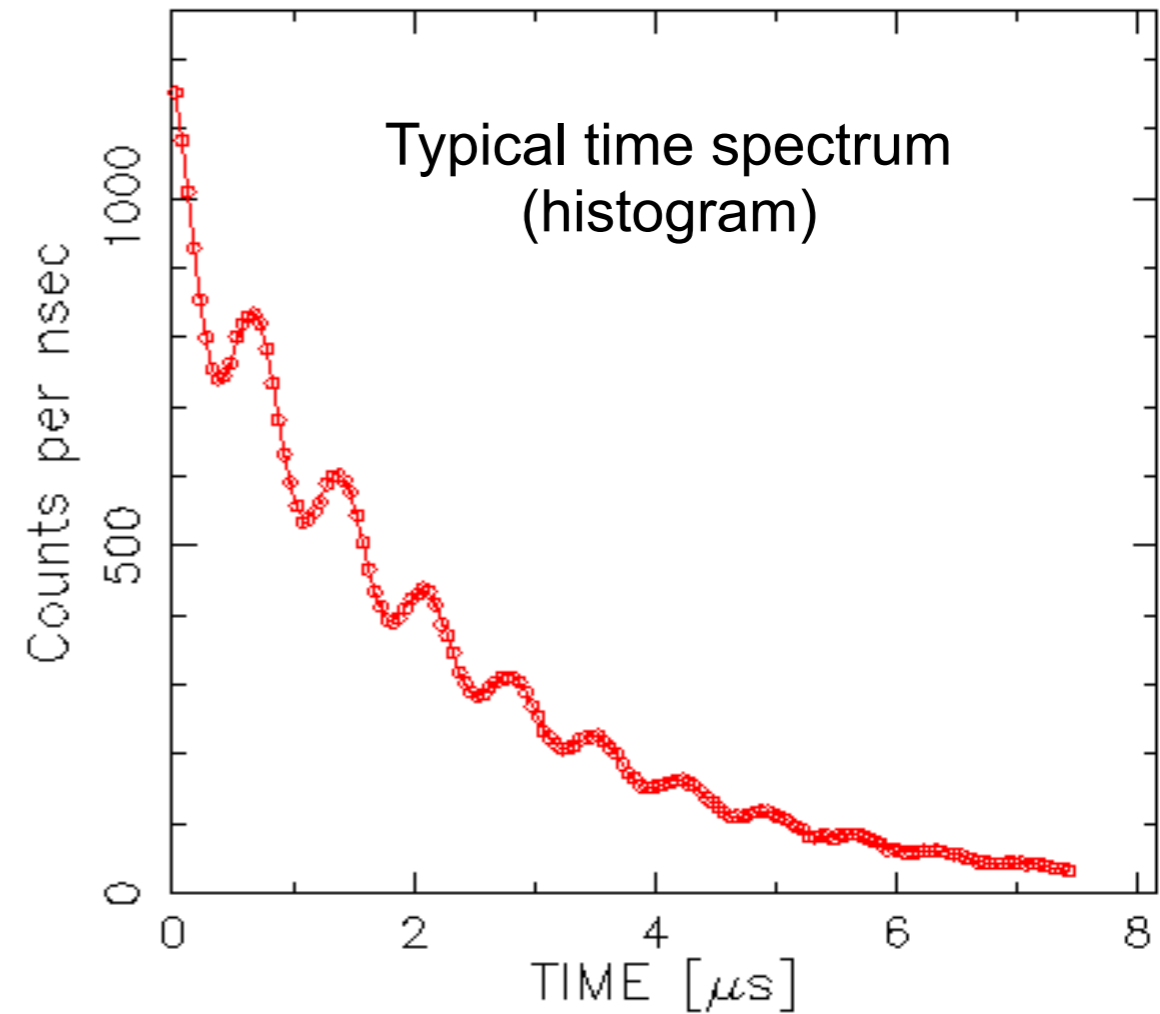
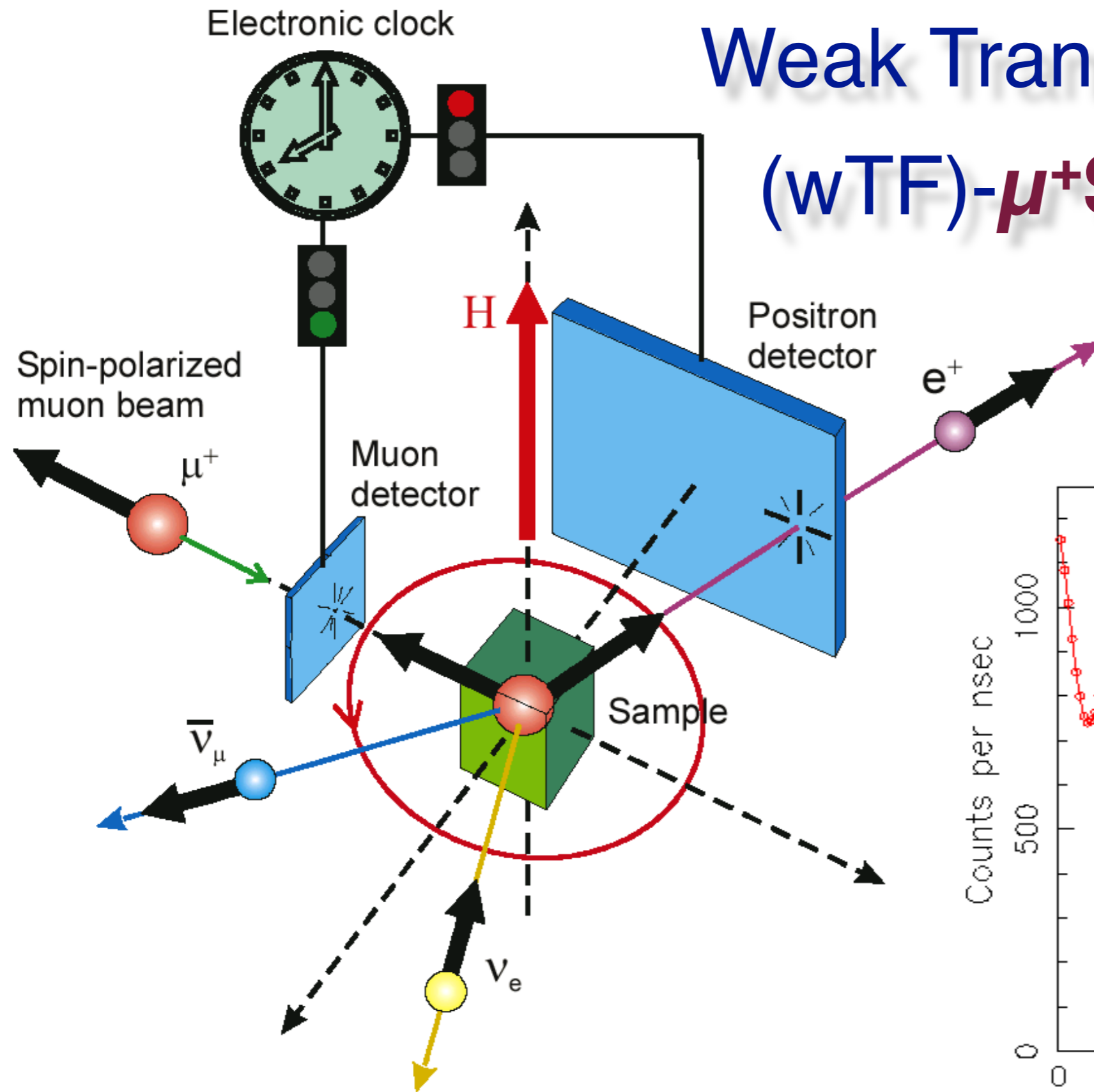

# 1958-1973: *Science Fiction*

- 1960s: **Fundamental Physics Fun!** – *Tours de Force*

**Michel Parameters** = Weak Interaction Laboratory

Heroic **QED** tests:  $A_{HF}(\text{Mu})$ ,  $\mu\mu$ ,  $g_\mu - 2$

All lead to *refined  $\mu$ SR techniques*.

**Applications:** **Muonium Chemistry**, Semiconductors, Magnetism

- 1972: **Bowen & Pifer** build first Arizona/**surface muon beam** to search for for  $\mu^+e^- \rightarrow \mu^-e^+$  conversion

- mid-1970s: **Meson Factories** – *Intensity Enables!*

USA: **LAMPF** (now defunct)

Switzerland: **SIN** (now **PSI**)

Canada: **TRIUMF**

UK: **RAL/ISIS**

Japan: **KEK/BOOM** ( → **J-PARC**)

# $\mu$ SR today: Routine Science?

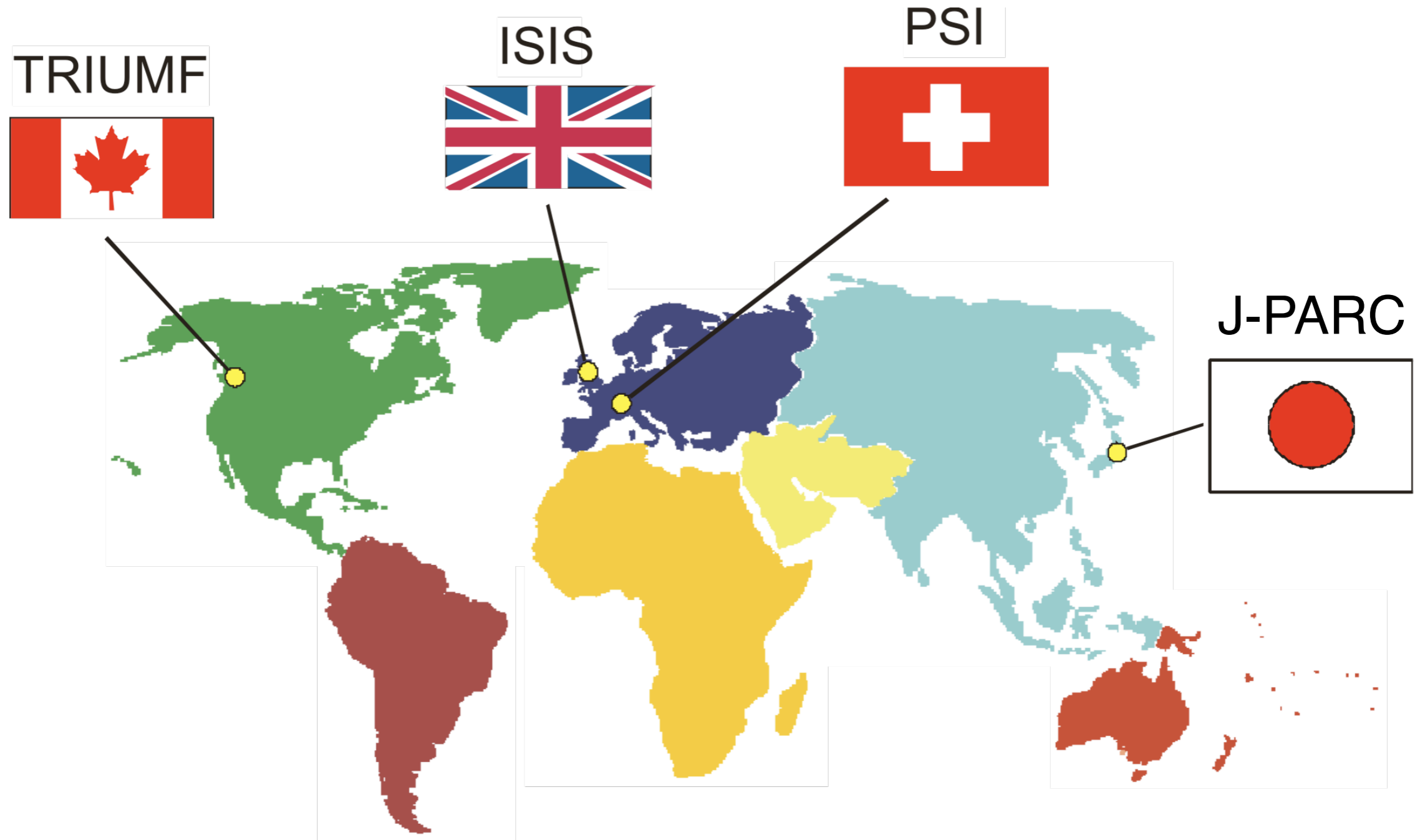

# $\mu$ SR today: Routine Science?

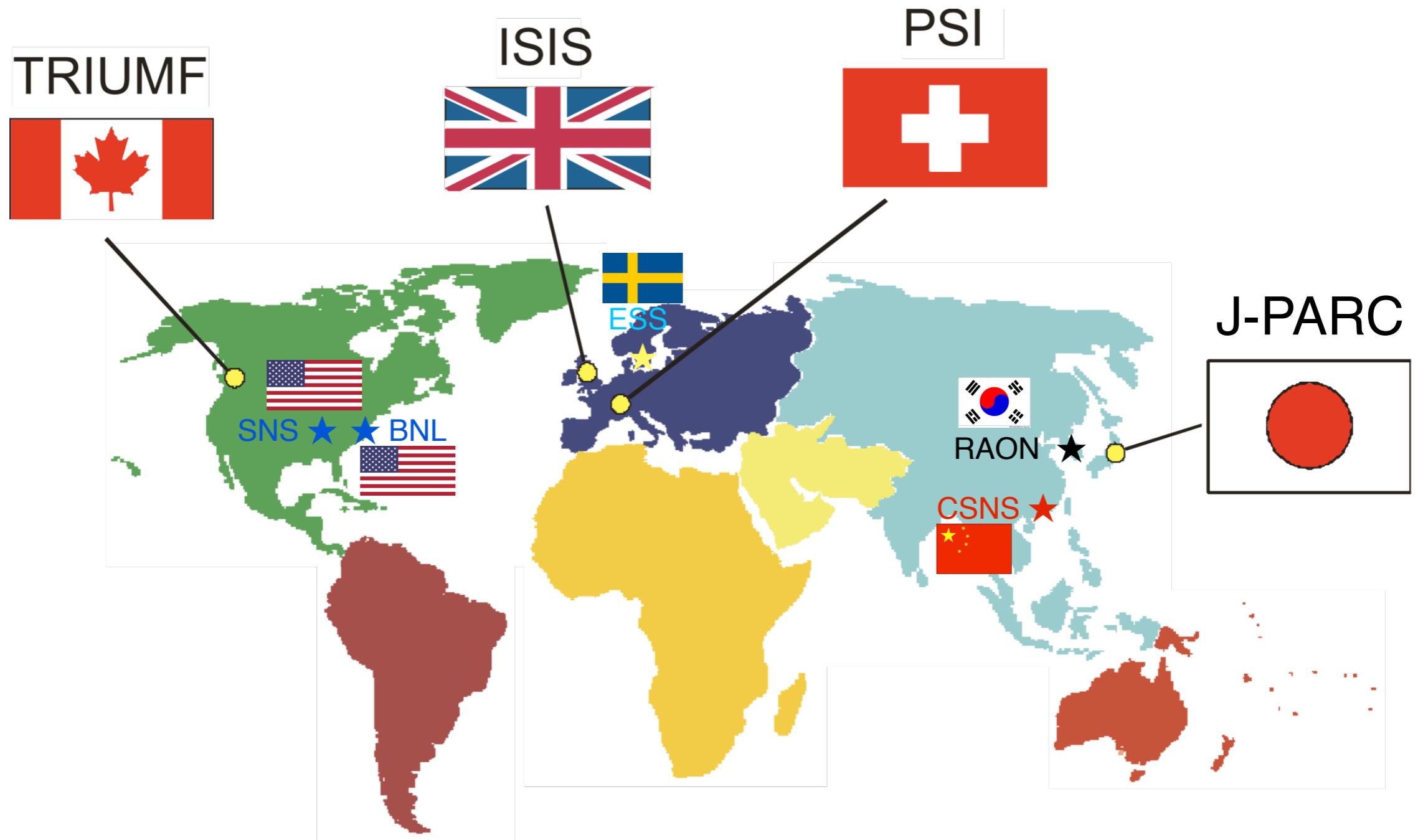

# ISIS site plan

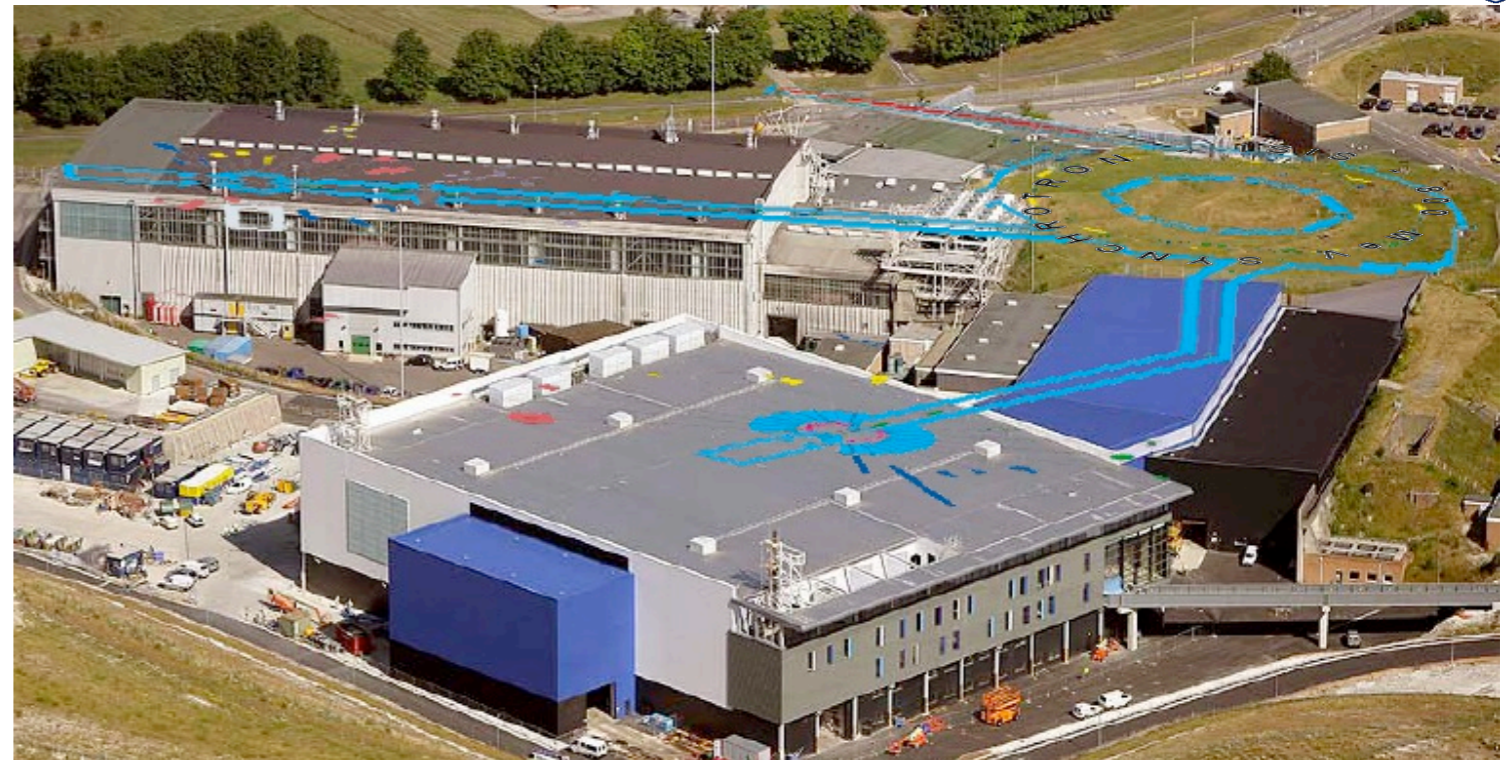
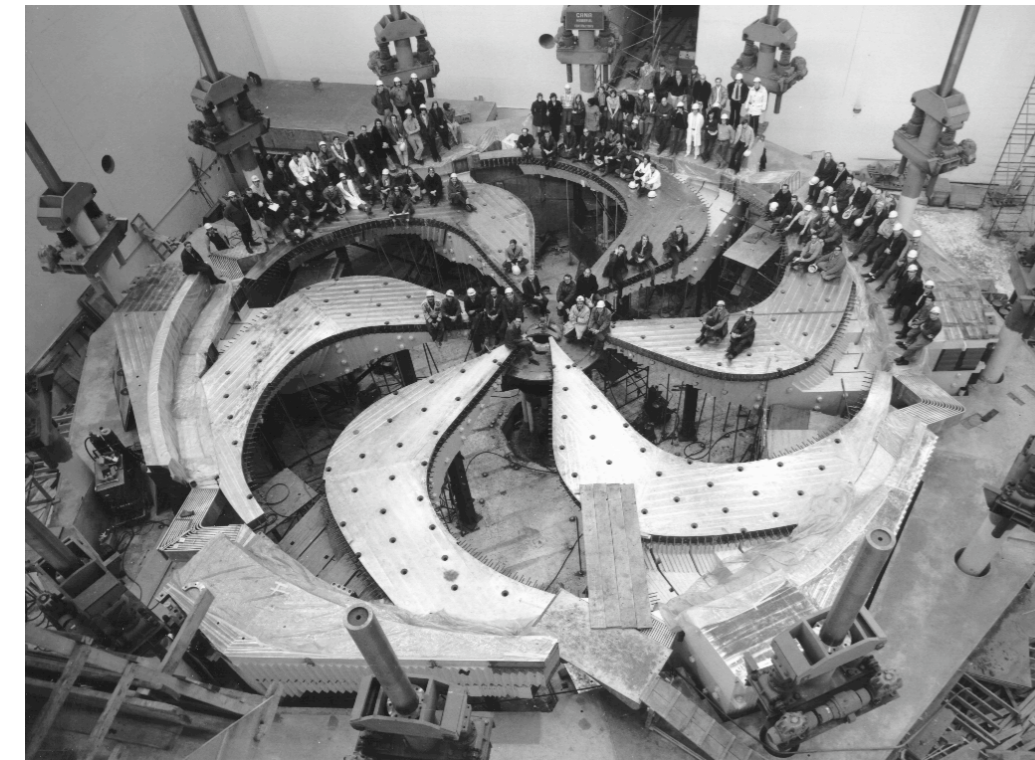

# PSI Ring Cyclotron

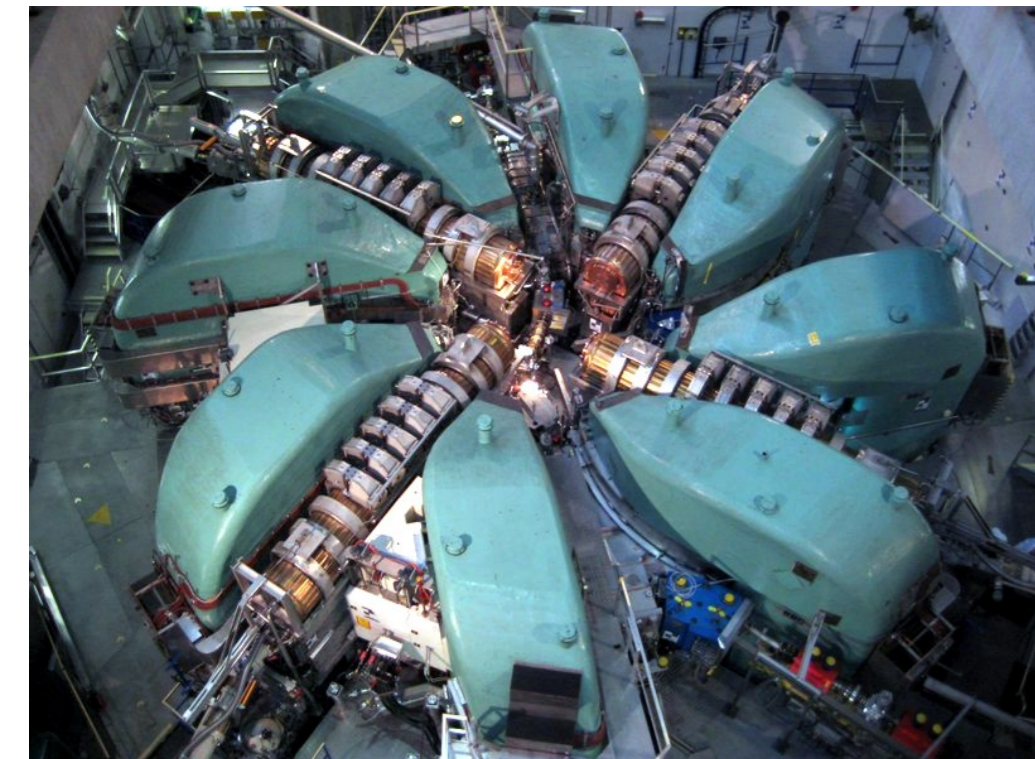

# J-PARC synchrotron





# CW vs. Pulsed $\mu SR$

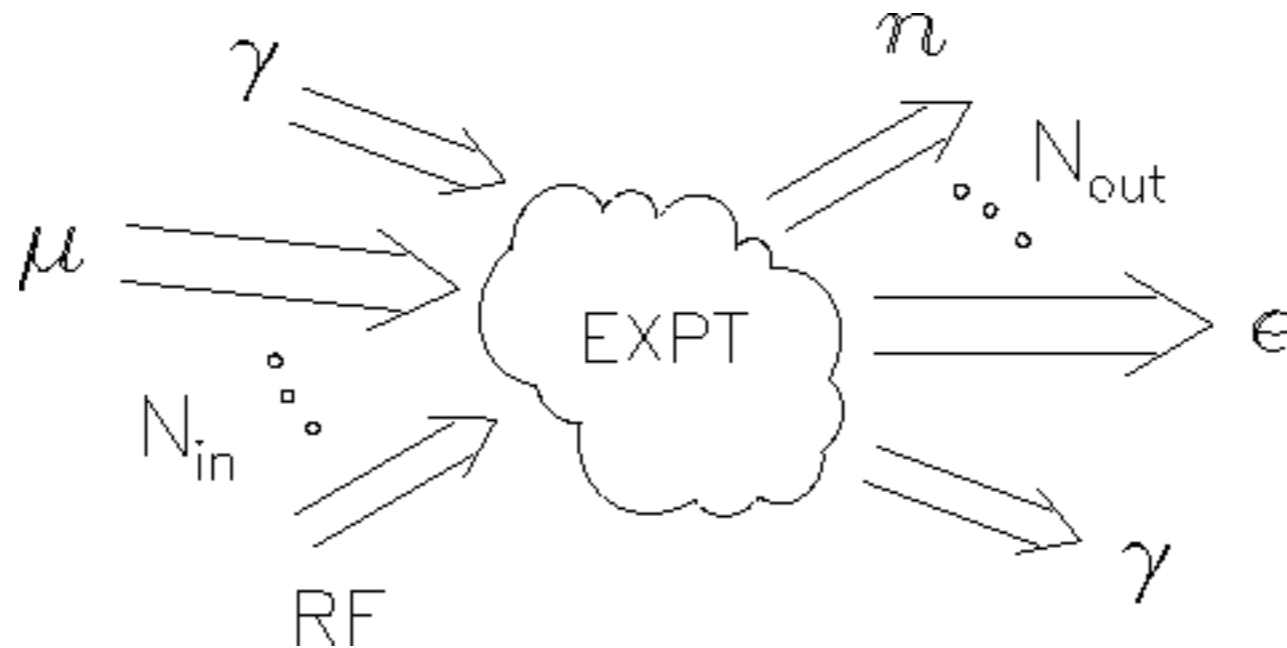

“Advantage factor” for *pulsed* muons:

$$A_p = \log(N_{in} / N_{out})$$

Advantage of CW muons: **time resolution** ( $< 1$  ns vs.  $> 10$  ns)

Disadvantage of CW muons: **rate** ( $< 10^4$  s $^{-1}$  vs. “unlimited”)

TRIUMF

# CW vs. Pulsed $\mu SR$

PSI

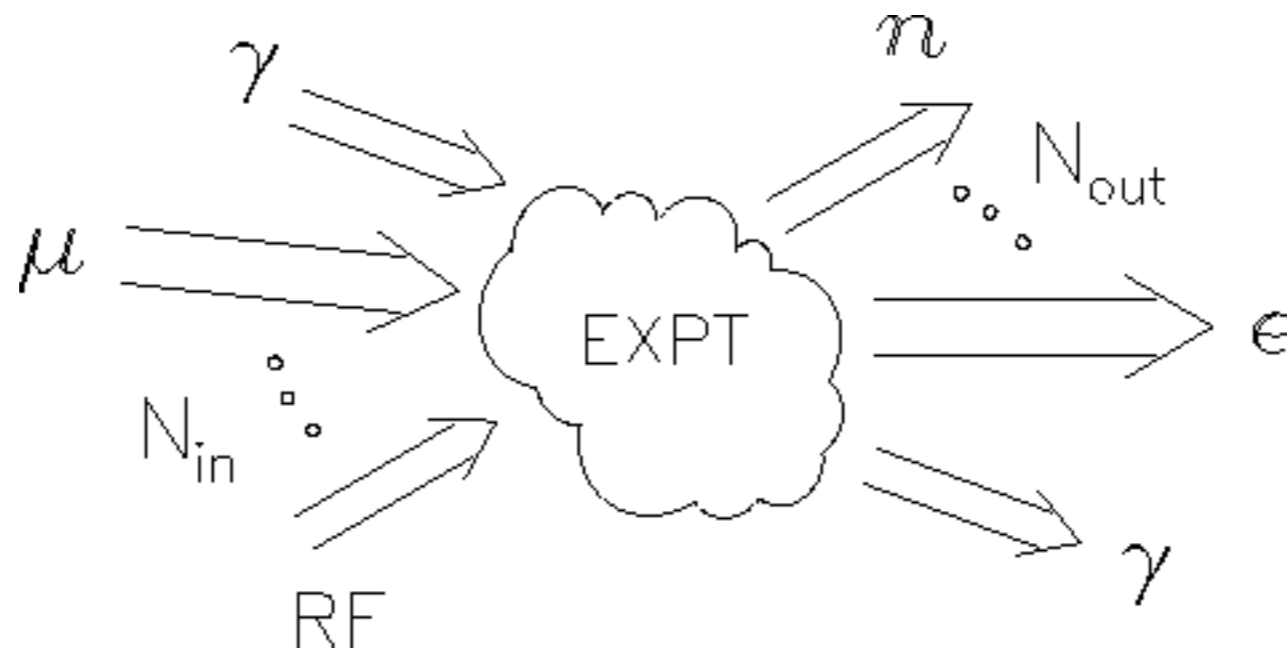

“Advantage factor” for *pulsed* muons:

$$A_p = \log(N_{in} / N_{out})$$

Advantage of CW muons: **time resolution** ( $< 1$  ns vs.  $> 10$  ns)

Disadvantage of CW muons: **rate** ( $< 10^4$  s $^{-1}$  vs. “unlimited”)

TRIUMF

ISIS

# CW vs. Pulsed $\mu SR$

PSI

J-PARC

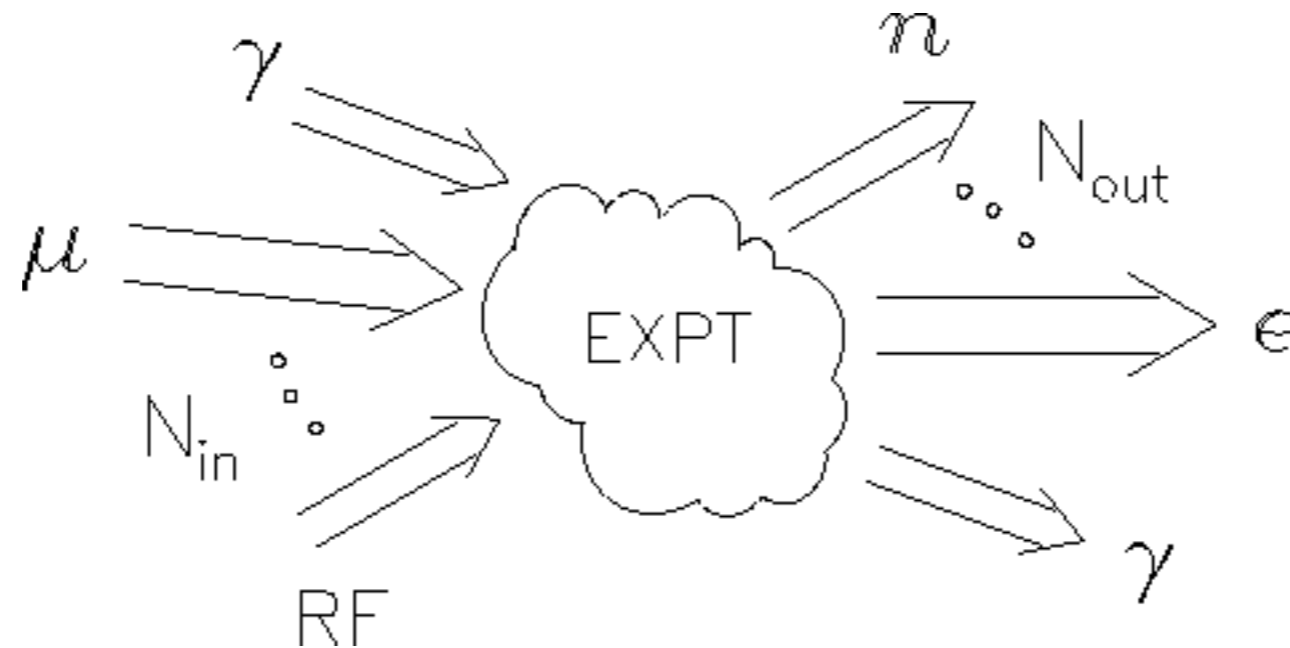

“Advantage factor” for *pulsed* muons:

$$A_p = \log(N_{in} / N_{out})$$

Advantage of CW muons: **time resolution** ( $< 1$  ns vs.  $> 10$  ns)

Disadvantage of CW muons: **rate** ( $< 10^4$  s $^{-1}$  vs. “unlimited”)

# Research “Themes” in $\mu^+SR$

## Muonium as light Hydrogen

(Mu =  $\mu^+e^-$ )

(H =  $p^+e^-$ )

- **Mu vs. H atom Chemistry:**
  - gases, liquids & solids
  - Best test of reaction rate theories.
  - Study “unobservable” H atom rxns.
  - Discover new radical species.
- **Mu vs. H in Semiconductors:**
  - Until recently,  $\mu^+SR$  → only data on metastable H states in semiconductors!
- **Quantum Diffusion:**  $\mu^+$  in metals (compare  $H^+$ ); Mu in nonmetals (compare H).

## The Muon as a Probe

- Probing **Magnetism:** unequalled sensitivity
  - Local fields: electronic structure; ordering
  - Dynamics: electronic, nuclear spins
- Probing **Superconductivity:** (esp.  $HT_cSC$ )
  - Coexistence of SC & Magnetism
  - Magnetic Penetration Depth  $\lambda$
  - Coherence Length  $\xi$

And then there's  $\mu^-SR$  ...

**And then there's  $\mu^-SR$  ...**

**... but there's not enough time  
for all its methods &  
applications.**

**:-(**

# $\mu^+SR$

vs.

# $\mu^-SR$

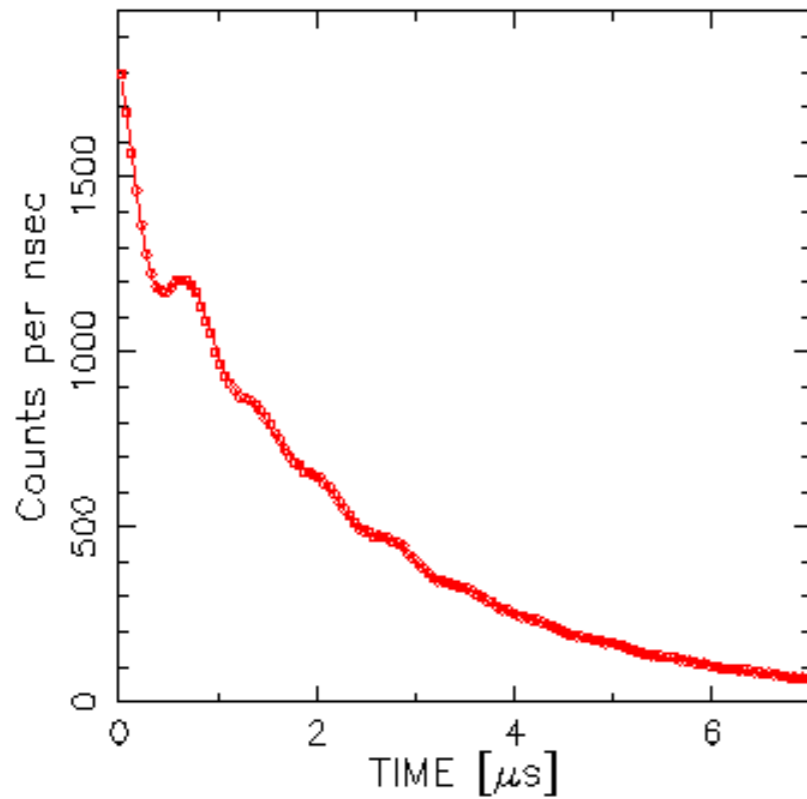

Typical time spectrum (histogram)

Single lifetime  $\tau_\mu = 2.197 \mu s$

Multiple lifetimes (some very short!)

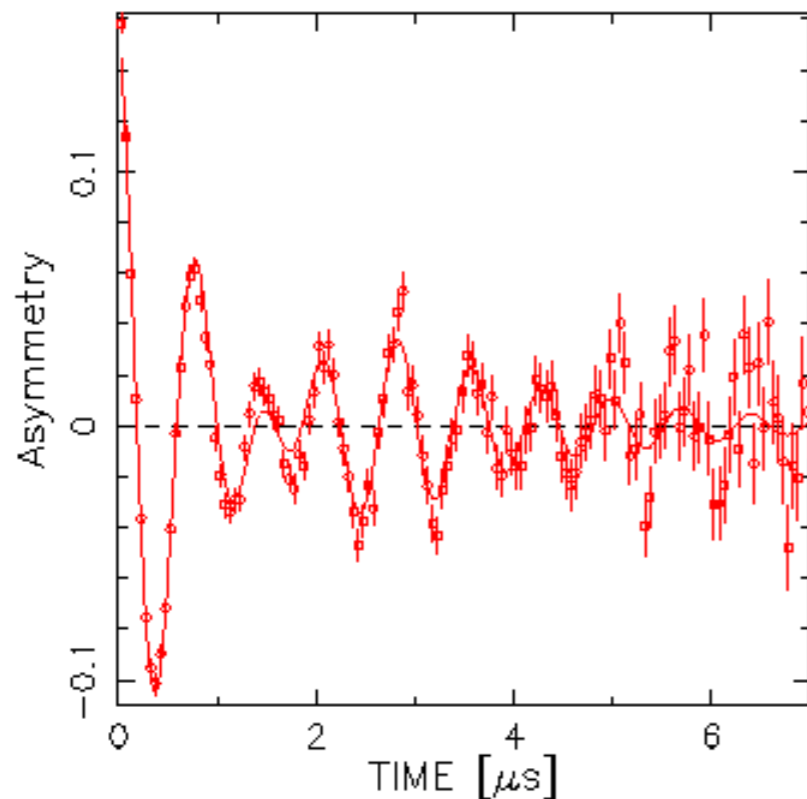
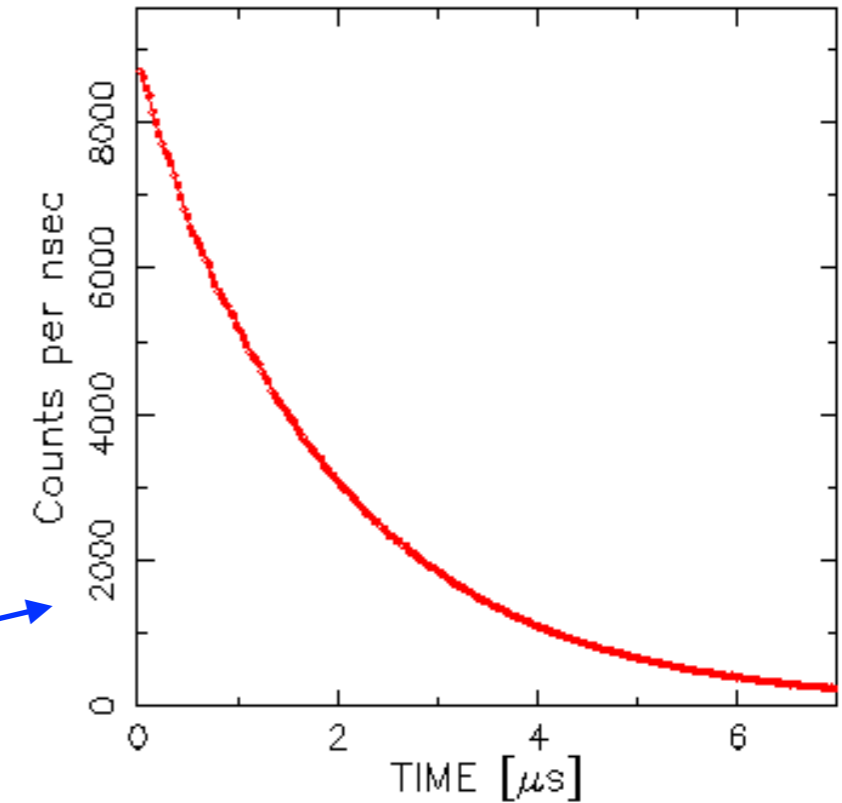

Asymmetry spectrum

Large amplitudes

Small amplitudes due to cascade depolarization

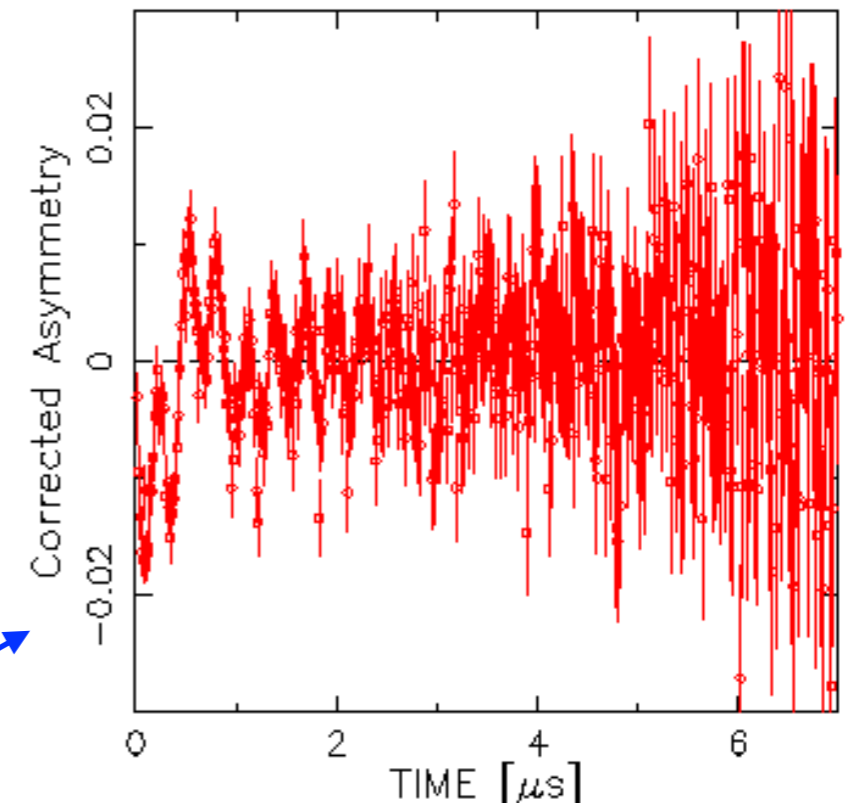

# MUON BEAMS

## DECAY MUON CHANNEL ( $\mu^+$ or $\mu^-$ )

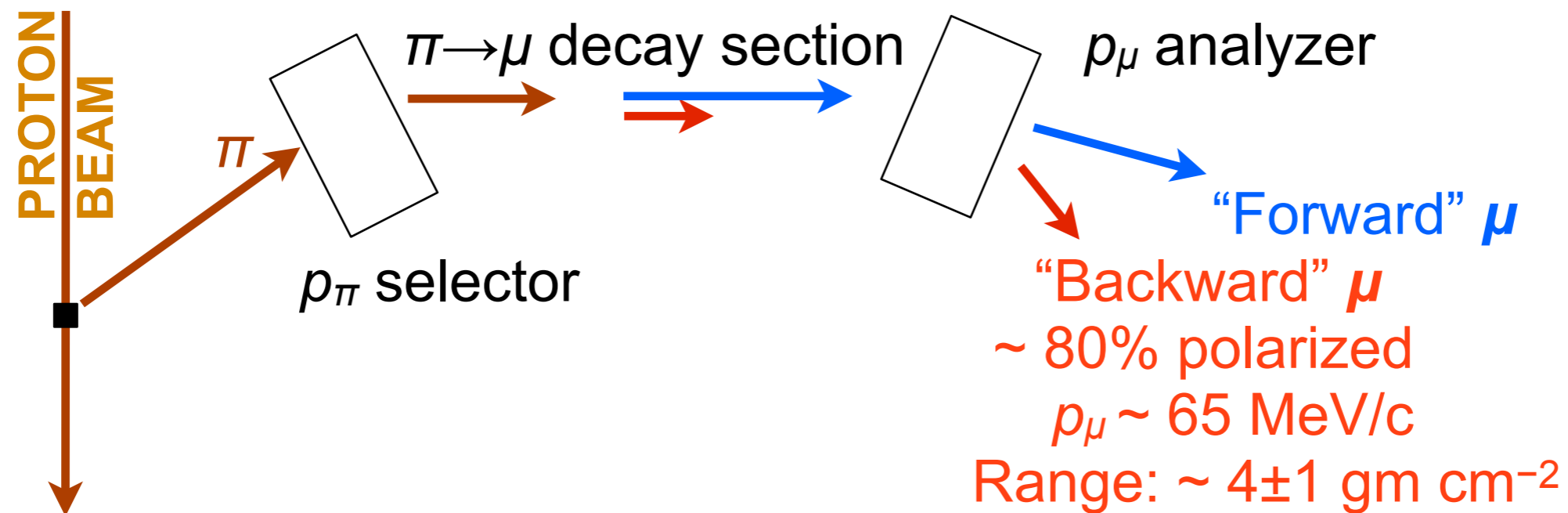



# Surface Muons

$\pi^+$  : all energies & angles.

a.k.a. "Arizona muons"  
(Bowen & Pifer, U. Ariz. 1973)

$\mu^+$ : 4 MeV,  
100% spin  
polarized

Range:  $150 \pm 30$  mg/cm<sup>2</sup>.  
Bright, imageable source.

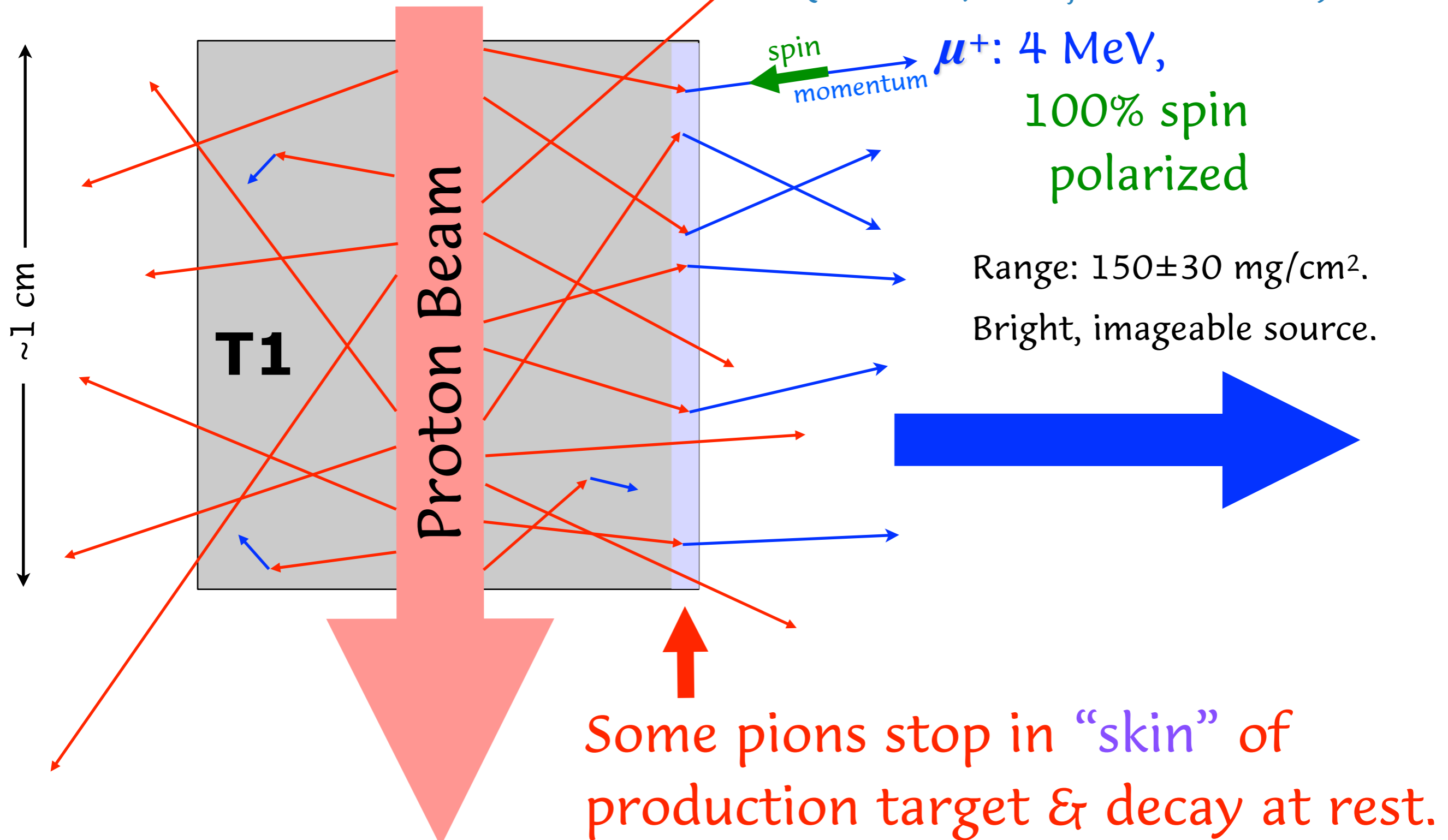

Some pions stop in "skin" of  
production target & decay at rest.

# Moderated Muons

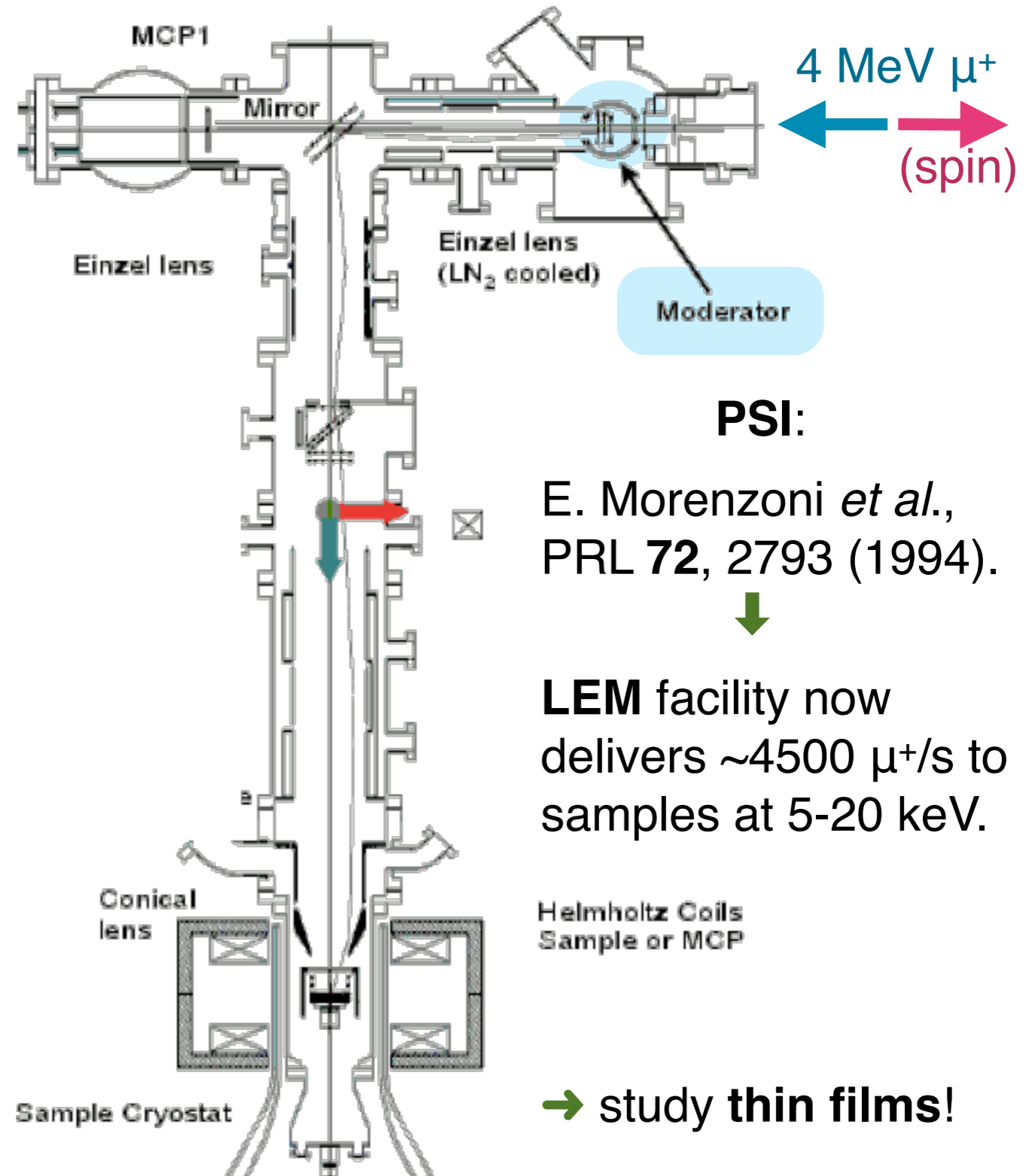
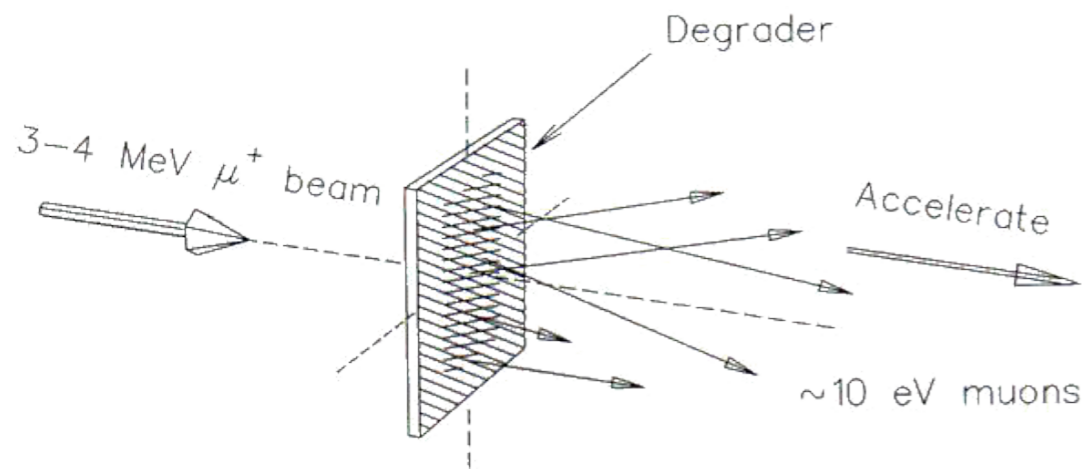

# Moderated Muons

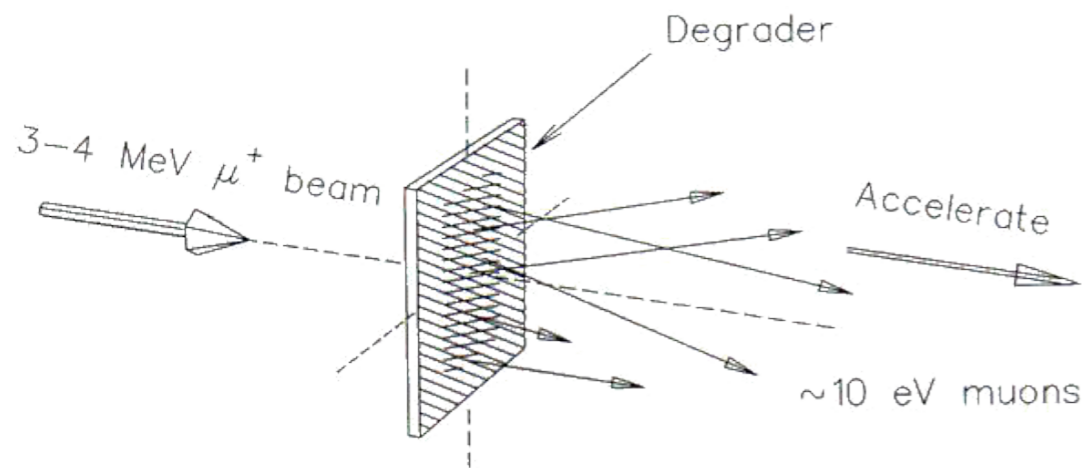

## TRIUMF:

D.R. Harshman *et al.*, PRL **56**, 2850 (1986).



G.D. Morris, M.Sc. thesis (1989).



Unfortunately, yield of 1.75(4) epithermal  $\mu^+$  per  $10^6$  incident surface muons (for a solid Ar moderator) was too low to be practical at TRIUMF intensities.

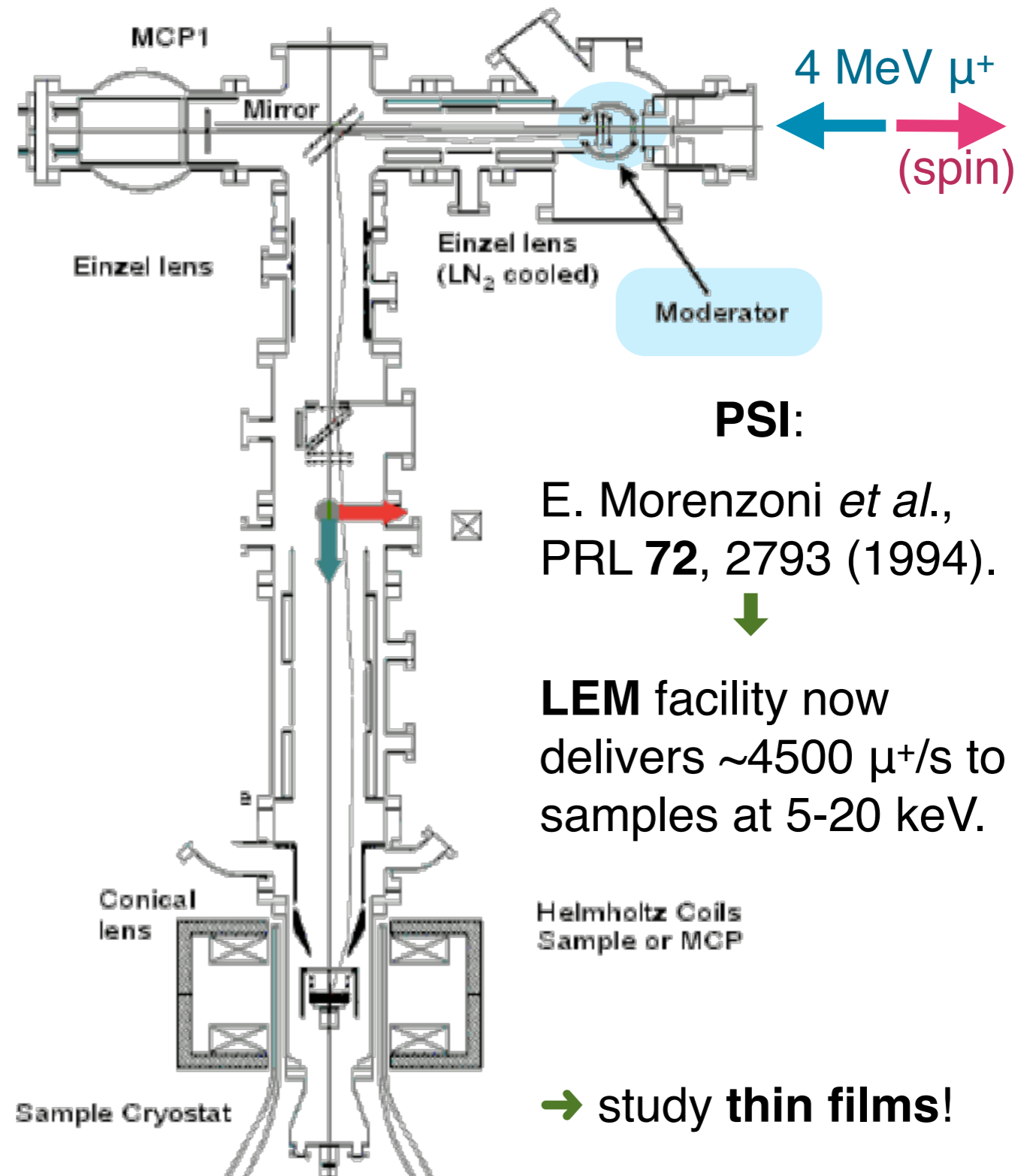

## PSI:

E. Morenzoni *et al.*, PRL **72**, 2793 (1994).



**LEM** facility now delivers  $\sim 4500$   $\mu^+$ /s to samples at 5-20 keV.

Helmholtz Coils  
Sample or MCP

→ study **thin films!**

# Laser-Ionize Thermal Muonium

## RIKEN-RAL (UK):

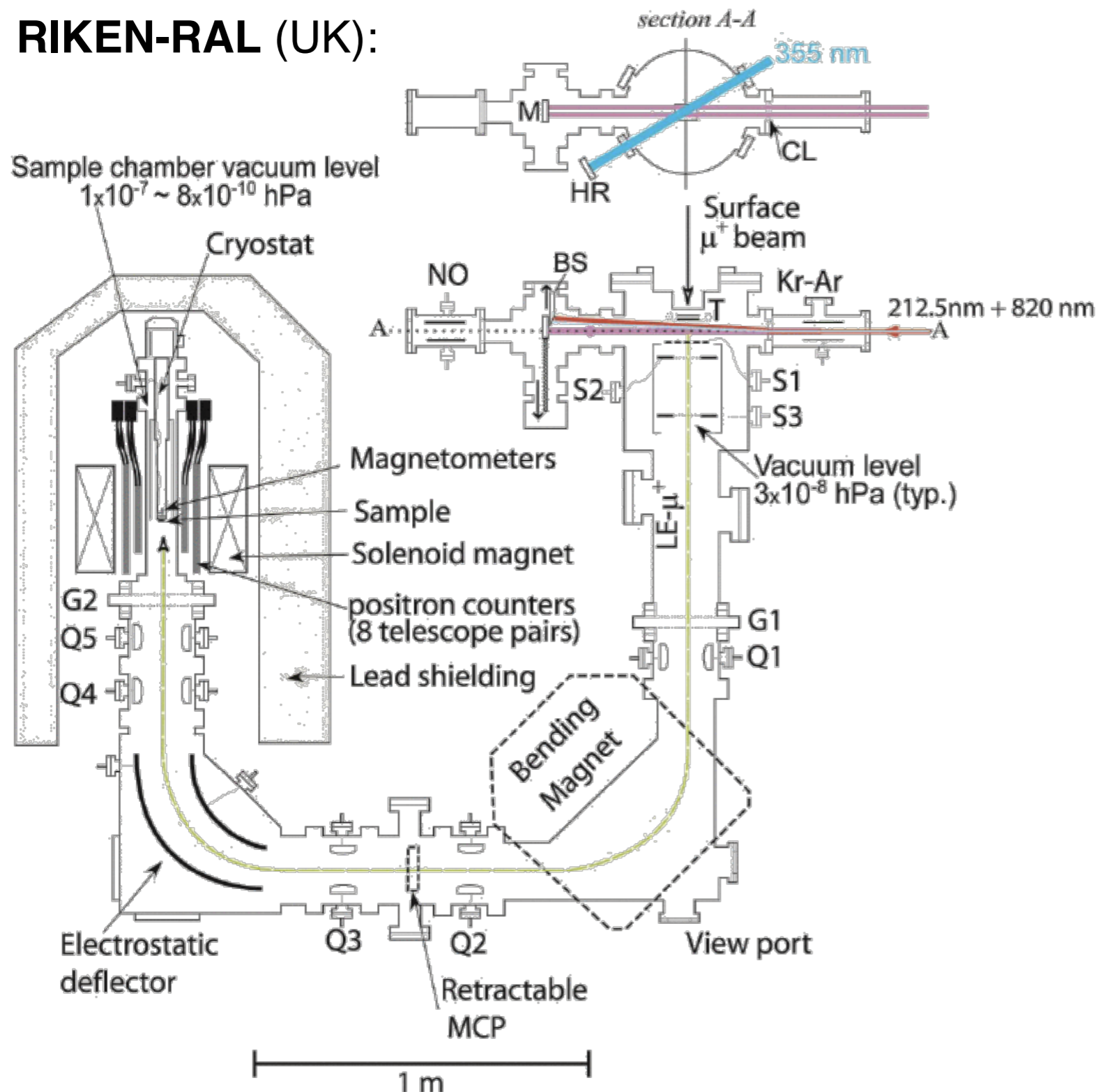

## J-PARC (Japan):

ULTRASLOW  
MUON  
MICROSCOPE



Advantage for **Pulsed** beams:  
re-accelerated pulse is *short*  
⇒ improved time resolution!

Low emittance ⇒ very small  
final focus! (“Microscope”)

→ More LE- $\mu$ SR

→ Improved muon  $g-2$

# $\mu^+$ Stopping Luminosity

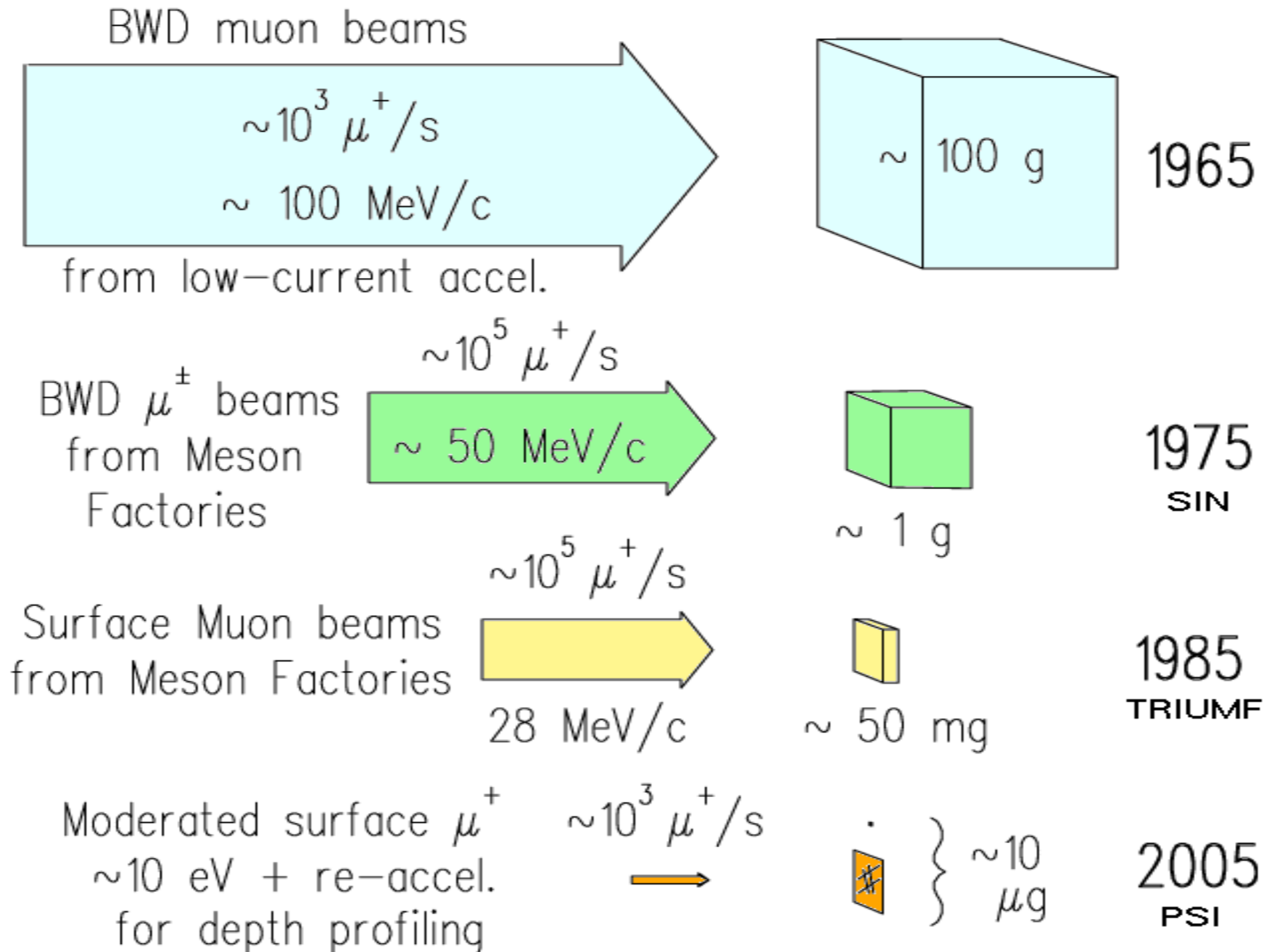

# $E \times B$ velocity selector & Spin Rotator

("DC Separator" or Wien filter)  
for **surface muons**:

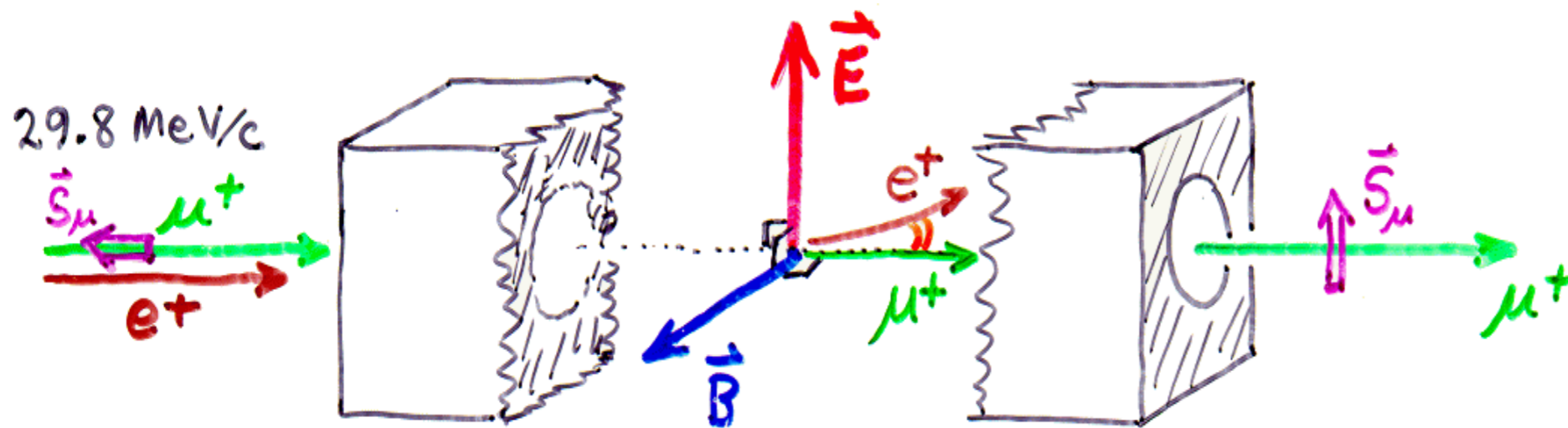

- Removes beam **positrons**
- Allows TF- $\mu^+$ SR in **high field** (otherwise  $B$  deflects beam)

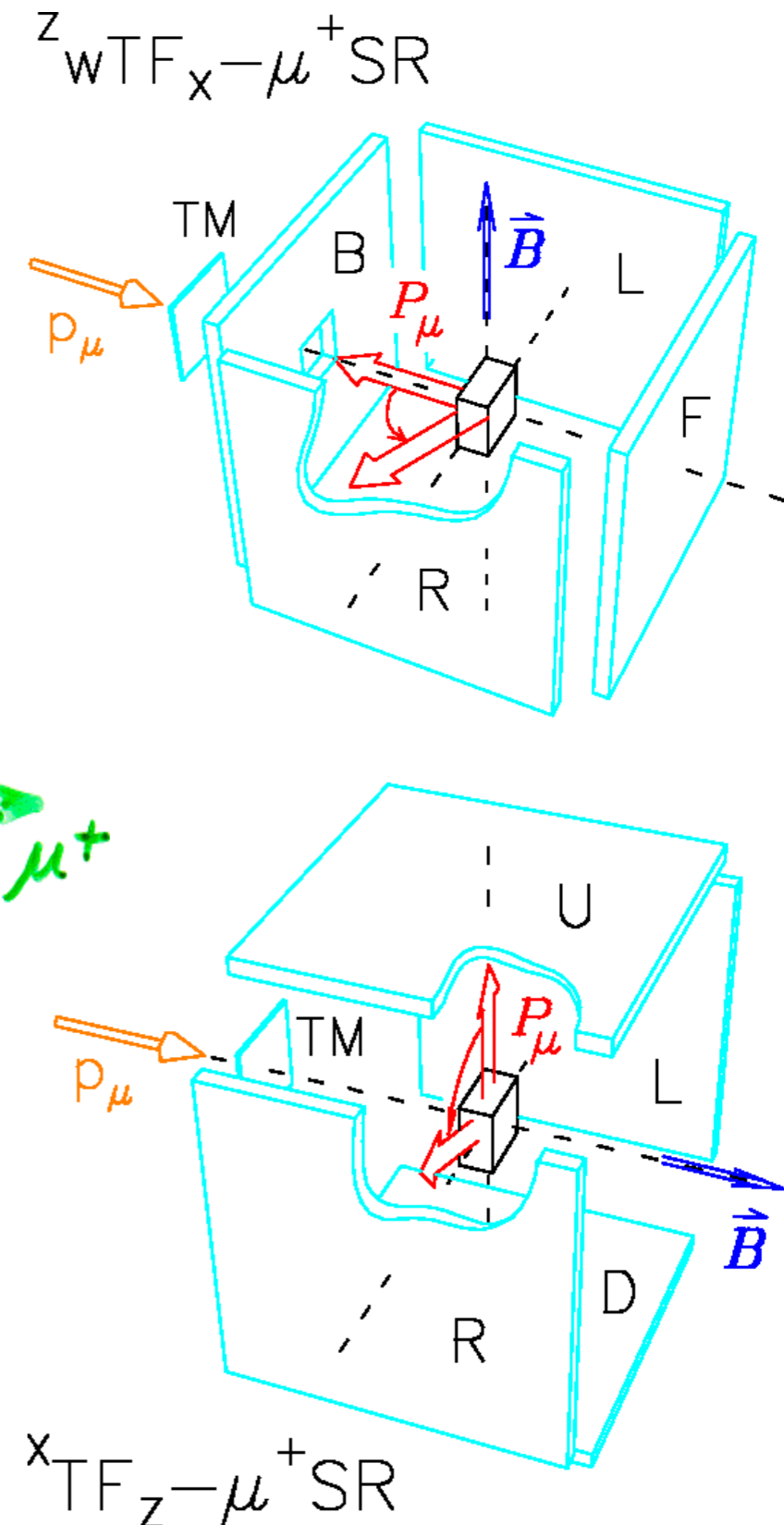

# High Field $\mu$ SR



Fields of up to 10 T are now available, requiring a “business end” of the spectrometer  $< 3$  cm in diameter (so that 30-50 MeV decay positron orbits don’t “curl up” and miss the detectors) and a time resolution of  $\sim 150$  ps. Muonium precession frequencies of over 2 GHz have been studied.

# Type-II Superconductors

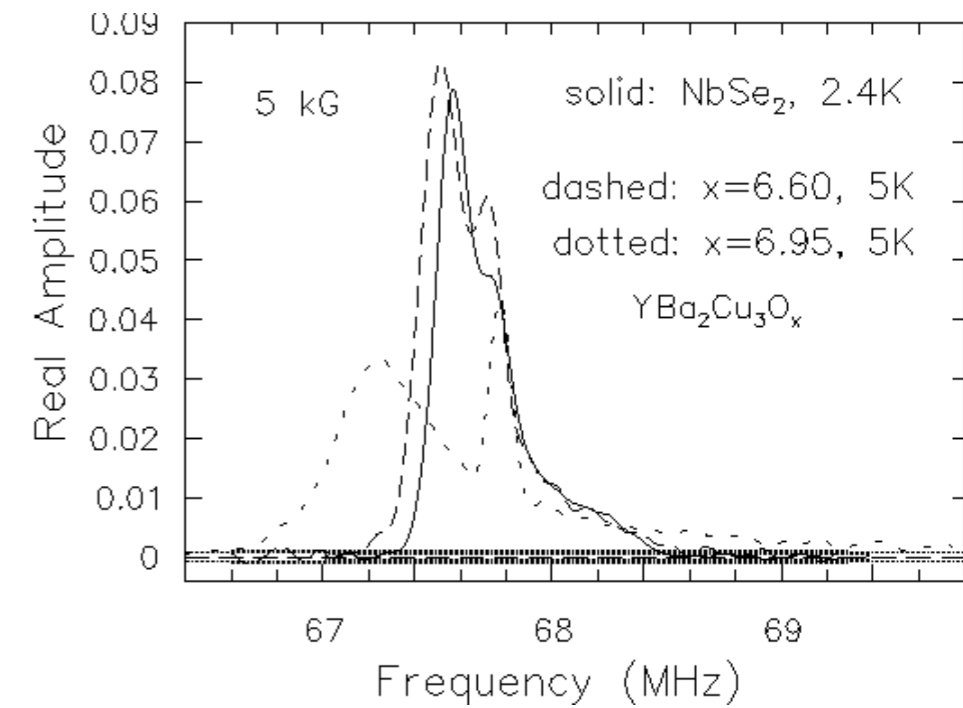
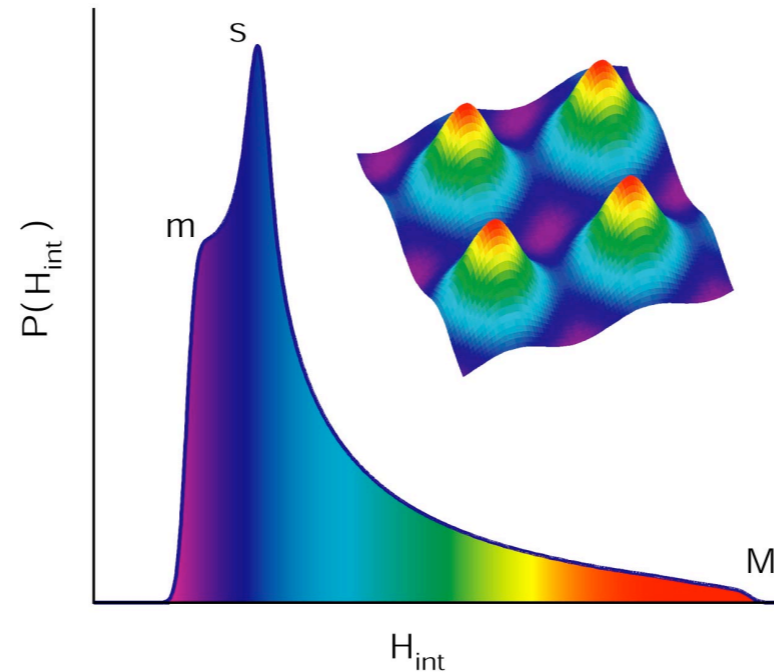
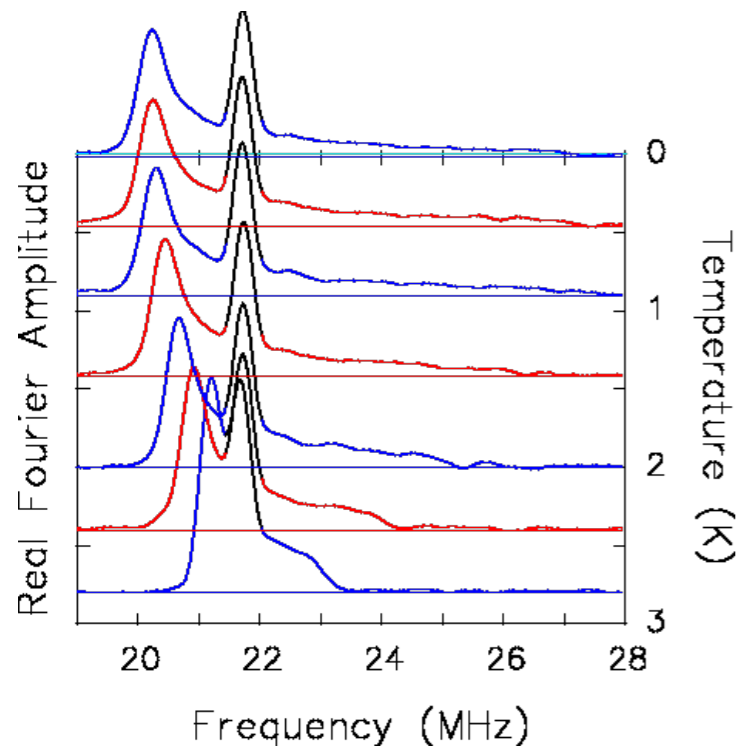

## Vanadium at 0.16 T

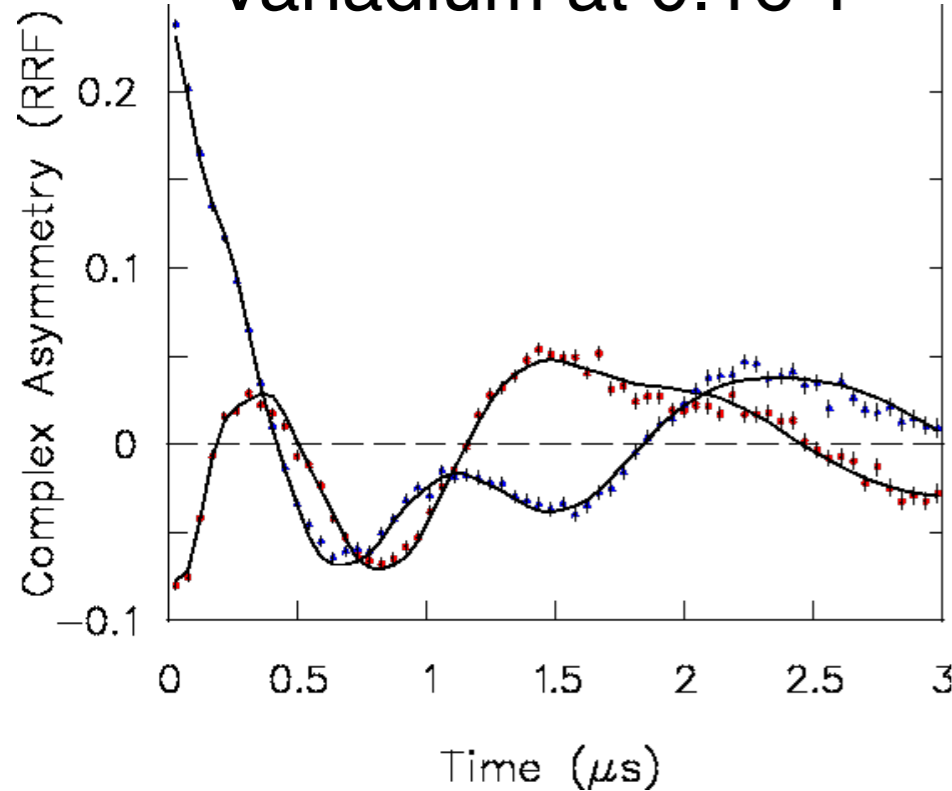

**Fitting** must always be done in the *time* domain, because of the “noise” from late times (low statistics).

Extract magnetic penetration depth  $\lambda_{ab}$

$$(\lambda_{ab}^{-2} \propto n_s).$$

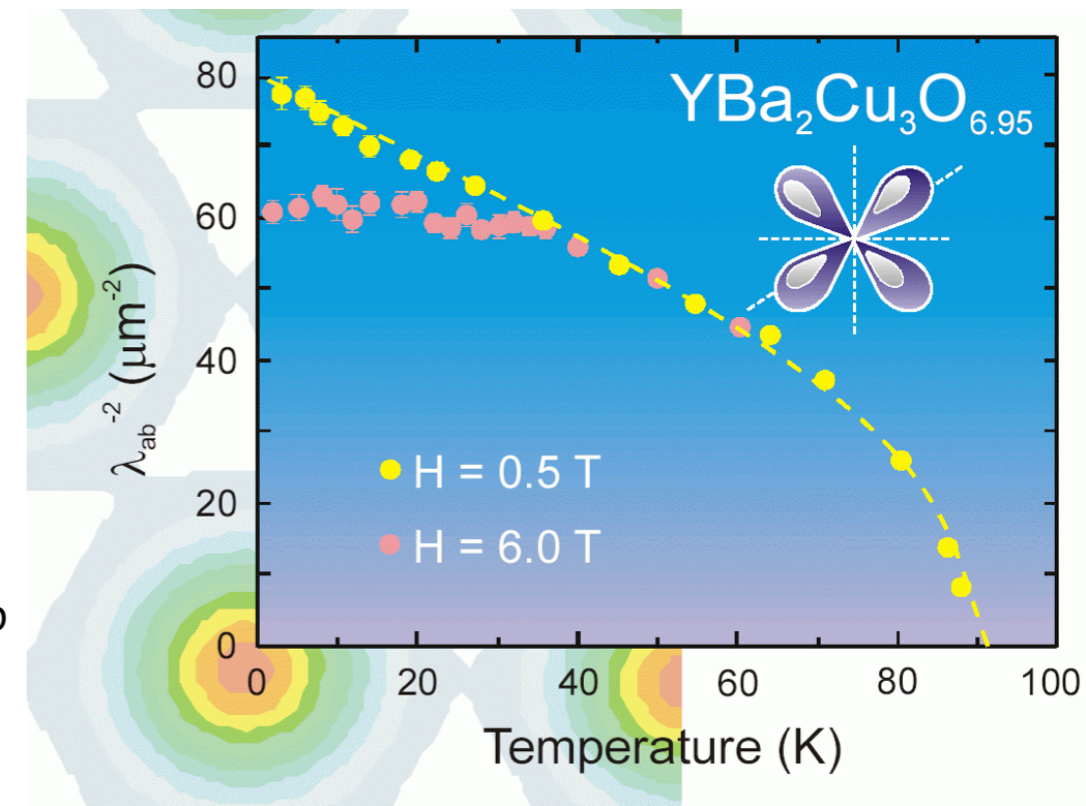



# Coexistence of SC & Magnetism

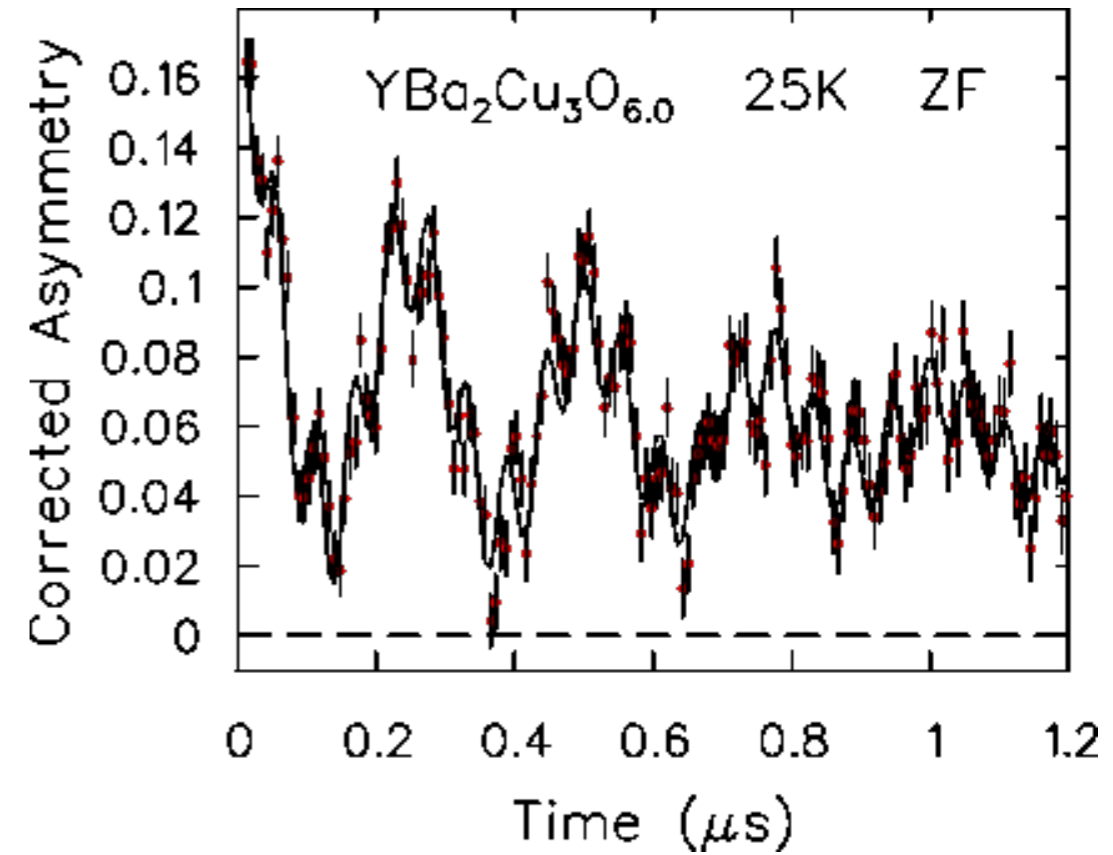
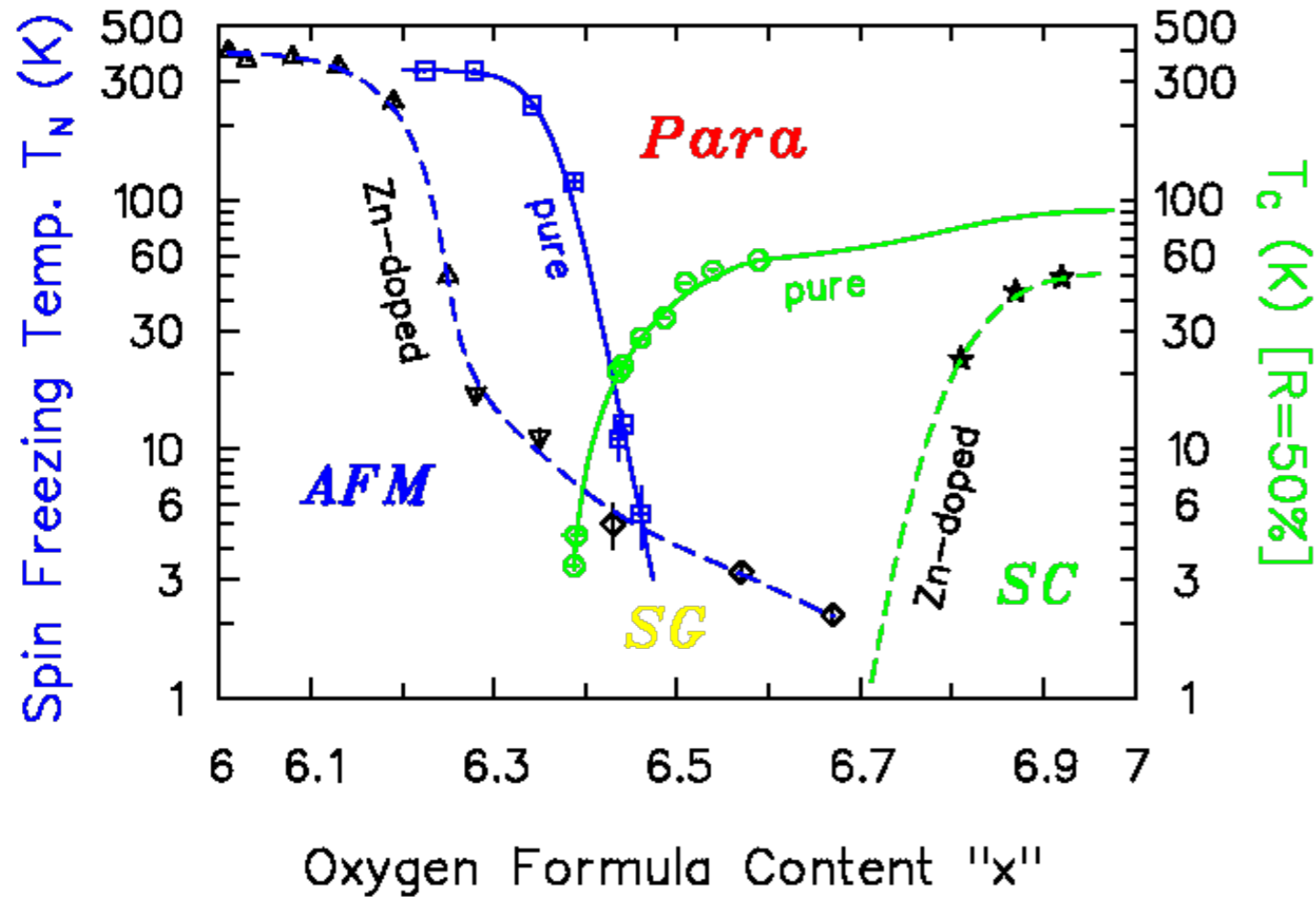

# ZF/LF- $\mu$ SR & Local Magnetic Fields

MnSi below 29 K: helimagnetic

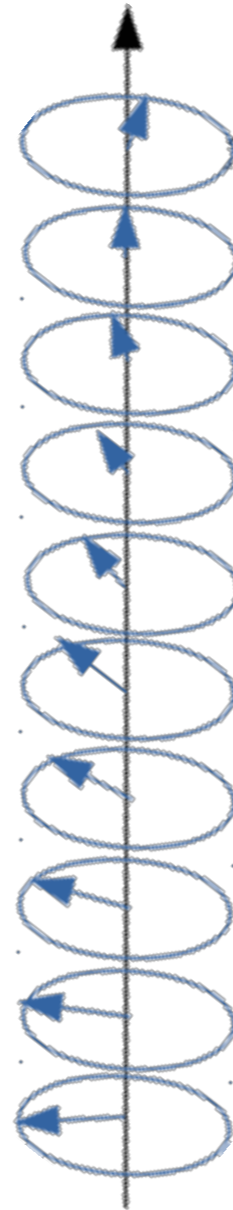
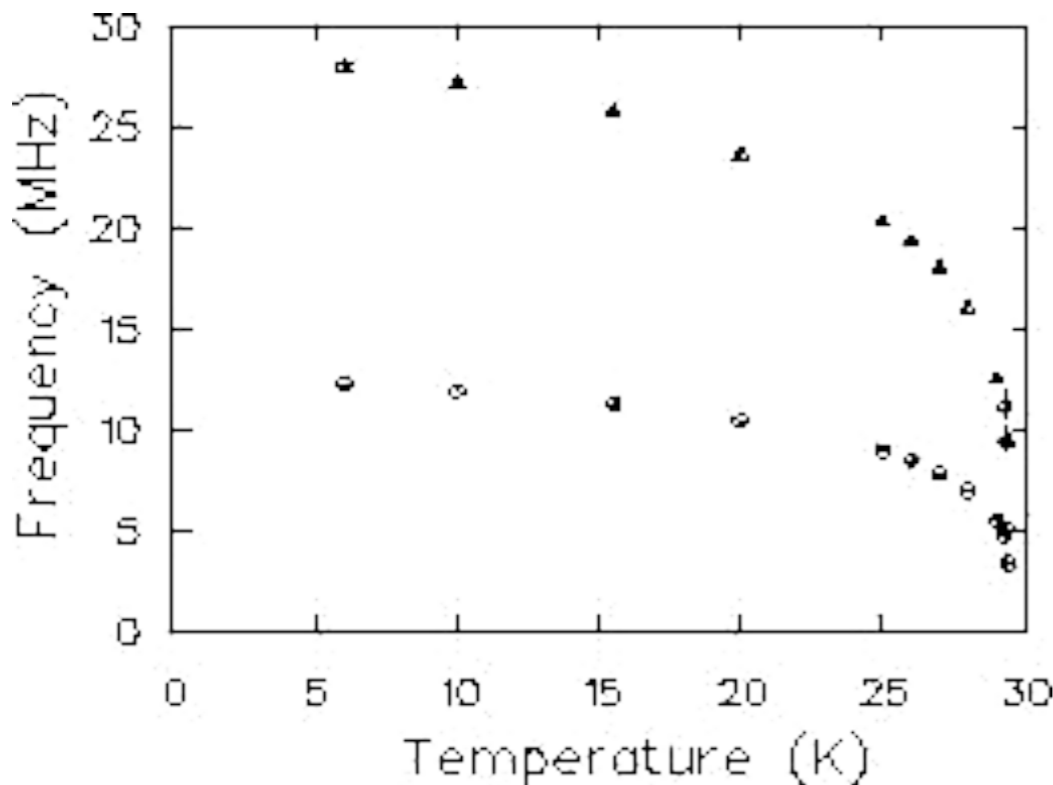
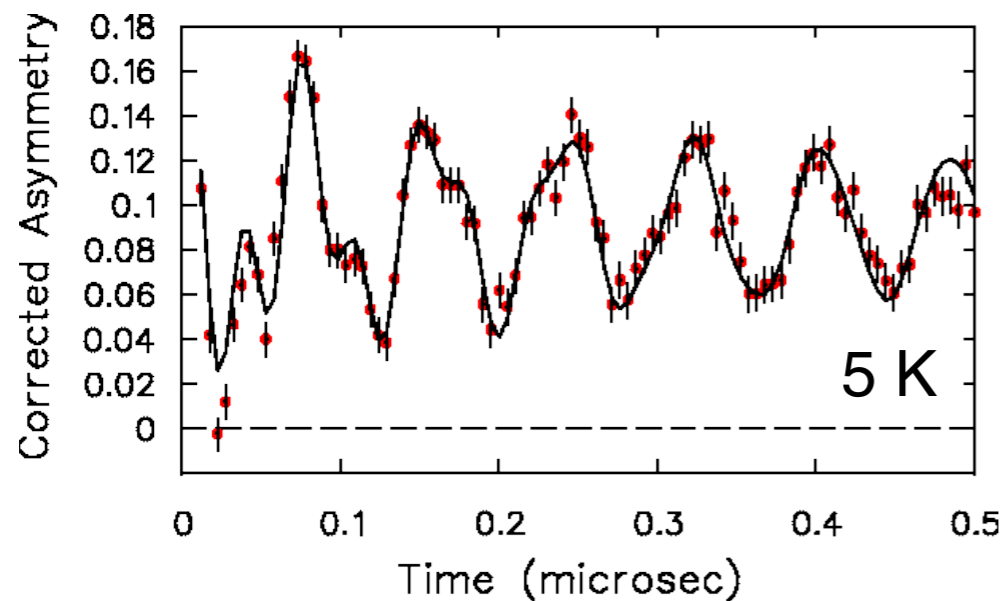

MnSi at 285 K: relaxation by static **nuclear dipolar fields** (PM moments flip too fast)

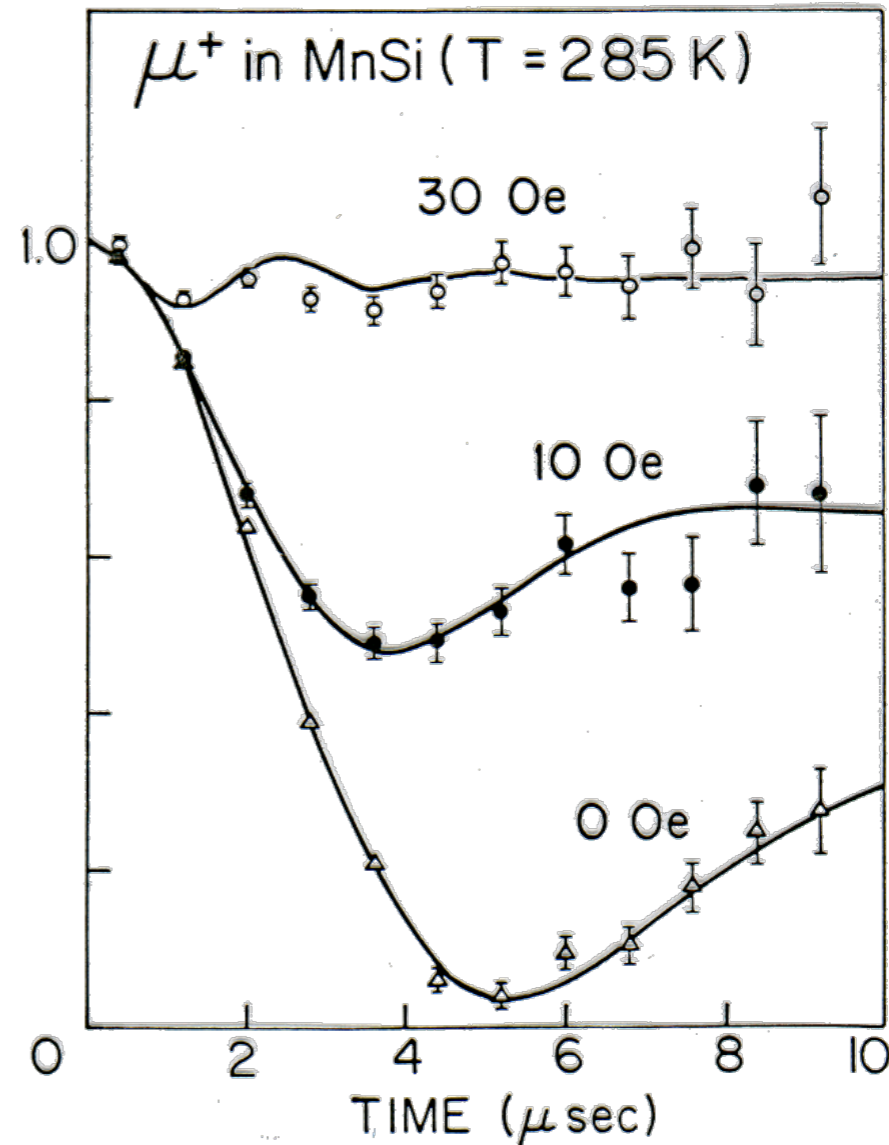

Hayano *et al.*  
TRIUMF - 1979

Decoupling by LF

Static Gaussian Kubo-Toyabe:  
 $g^{G_{zz}}(t)$

$$g^{G_{zz}}(t) = [1 + 2(1 - \Delta^2 t^2) \cdot \exp(-\Delta^2 t^2/2)] / 3$$

# ZF/LF- $\mu$ SR & Local Magnetic Fields

MnSi below 29 K: helimagnetic

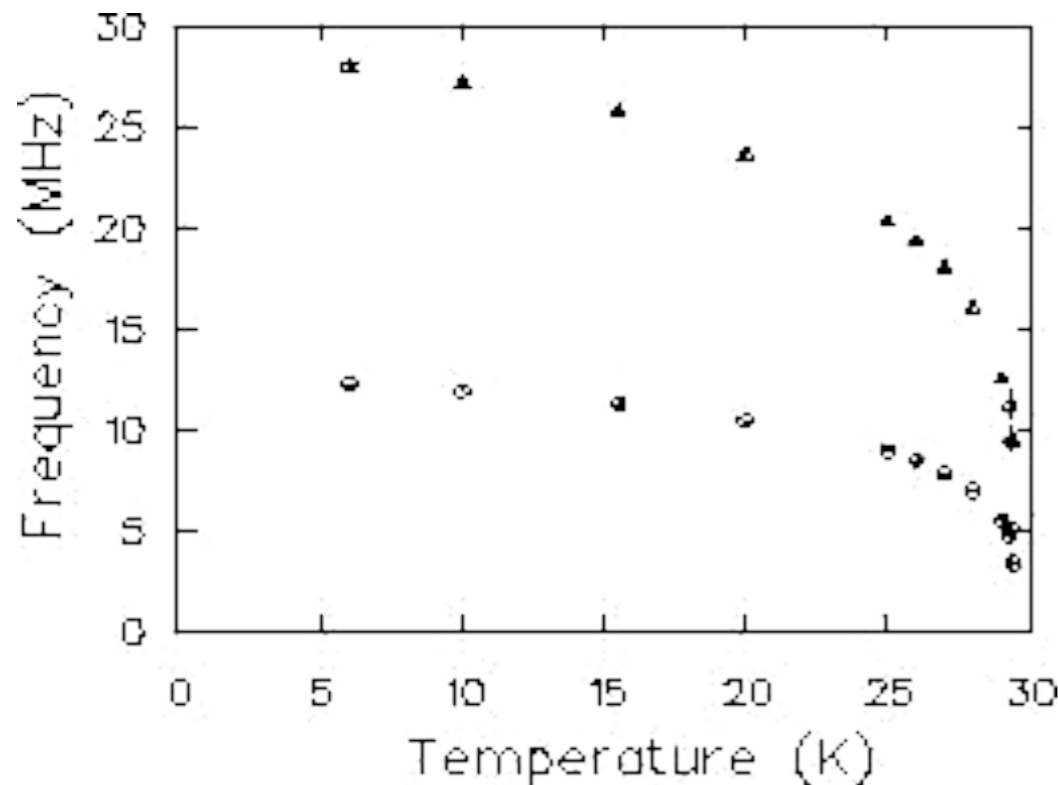
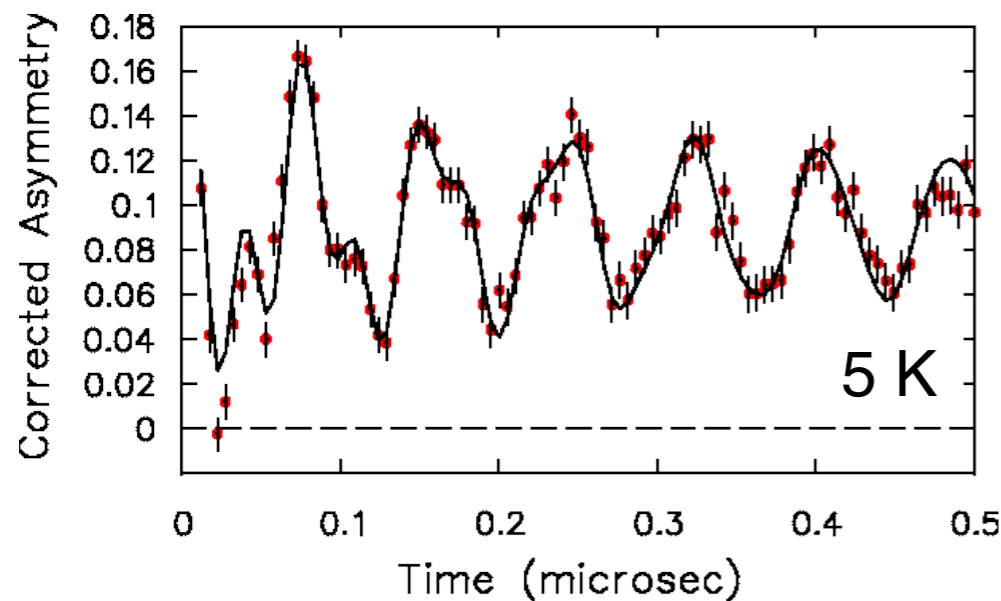

In between, things get very interesting...

MnSi at 285 K: relaxation by static **nuclear dipolar** fields (PM moments flip too fast)

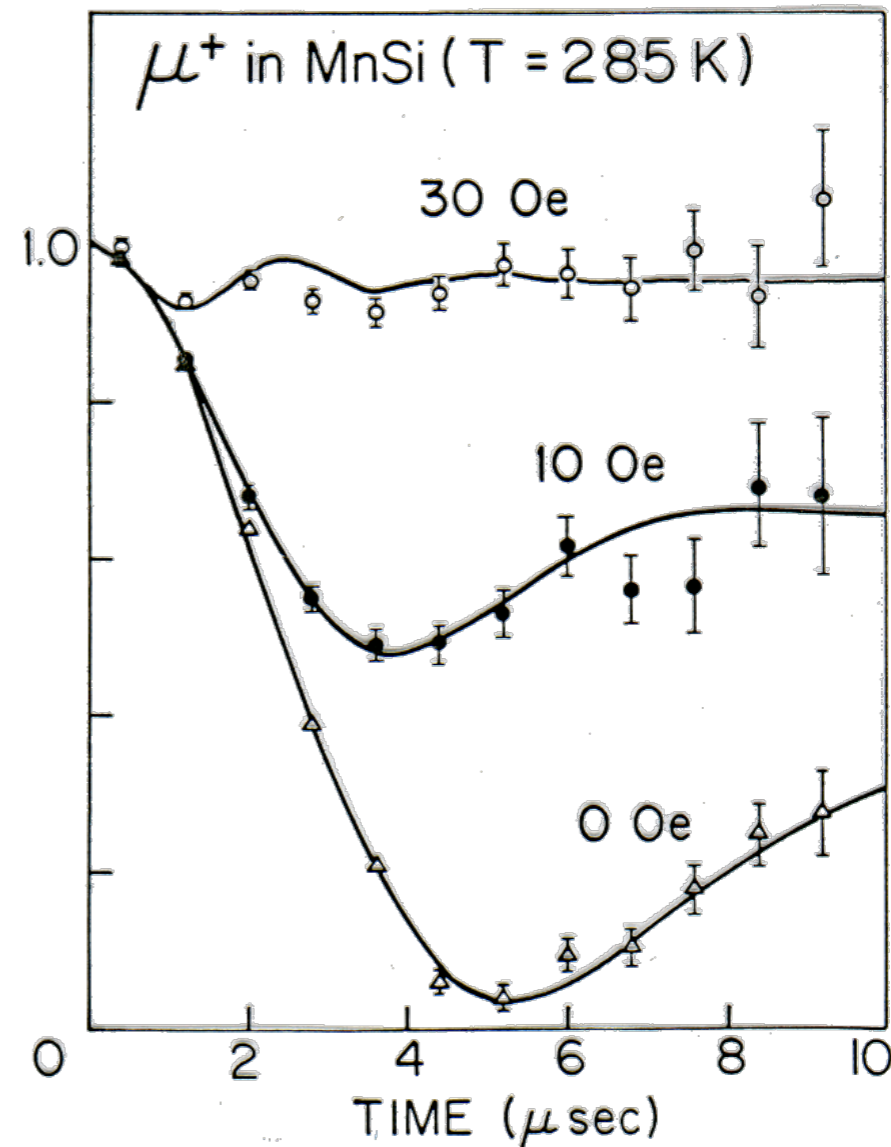

Hayano *et al.*  
TRIUMF - 1979

Decoupling by LF

Static Gaussian Kubo-Toyabe:  
 $g^{G_{zz}}(t)$

$$g^{G_{zz}}(t) = [1 + 2(1 - \Delta^2 t^2) \cdot \exp(-\Delta^2 t^2/2)] / 3$$

# Motion of $\mu^+$ Spins in Fluctuating Local Fields

“Strong Collision” model: local field is reselected at random from the same distribution each time a fluctuation takes place, either from muon hopping (plausible) or from reorientation of nearby moments (unlikely to change so completely).

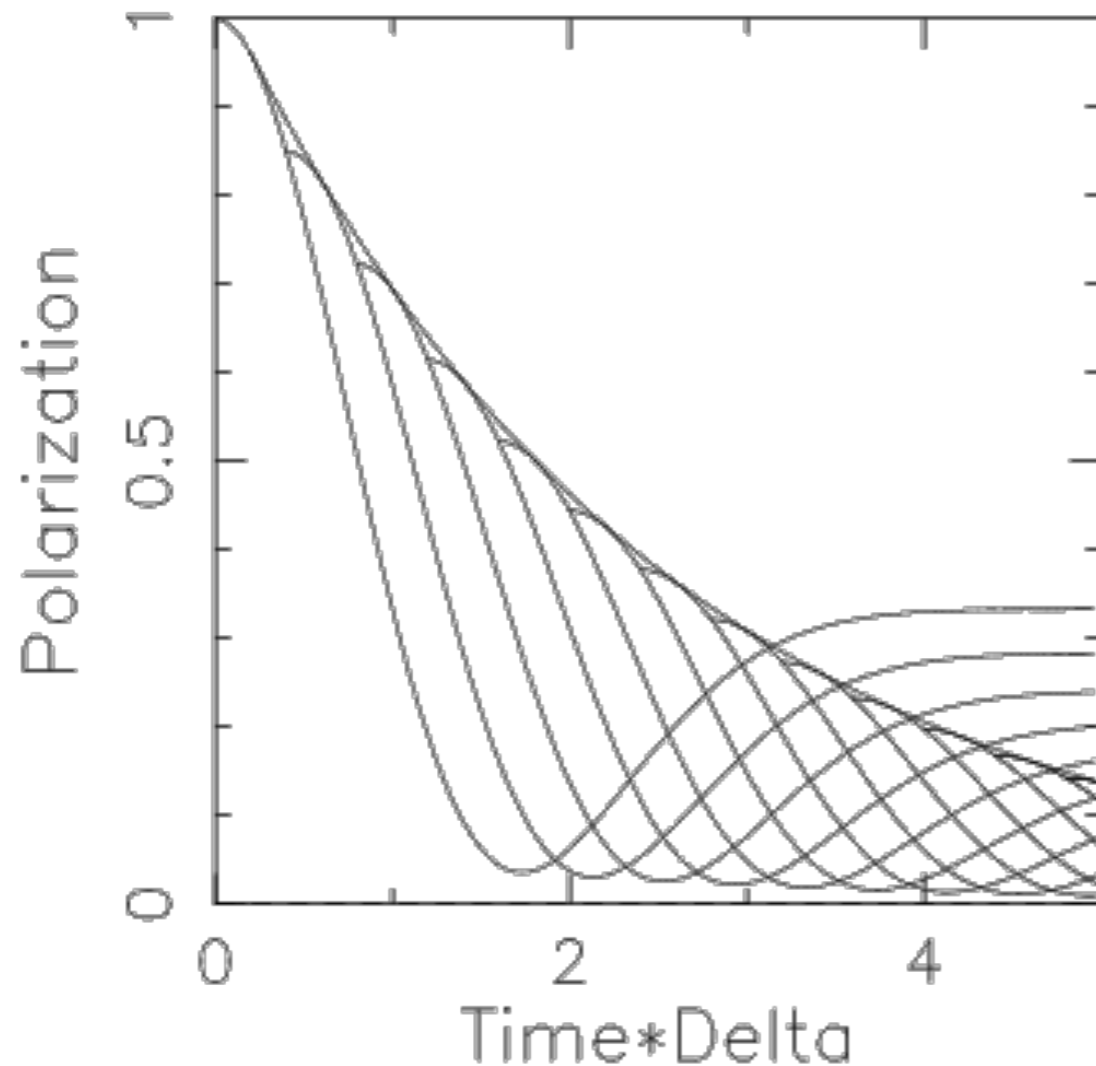

Kehr's recursion relation:

$$G(\Delta, t, \nu) = g(\Delta, t)e^{-\nu t} + \nu \int_0^t G(\Delta, t - \tau)g(\Delta, \tau) e^{-\nu\tau} d\tau$$

Sometimes solvable using Laplace transforms; numerical methods usually work too.

Used to extract “hop” or fluctuation rate  $\nu$ .

# Time Scales

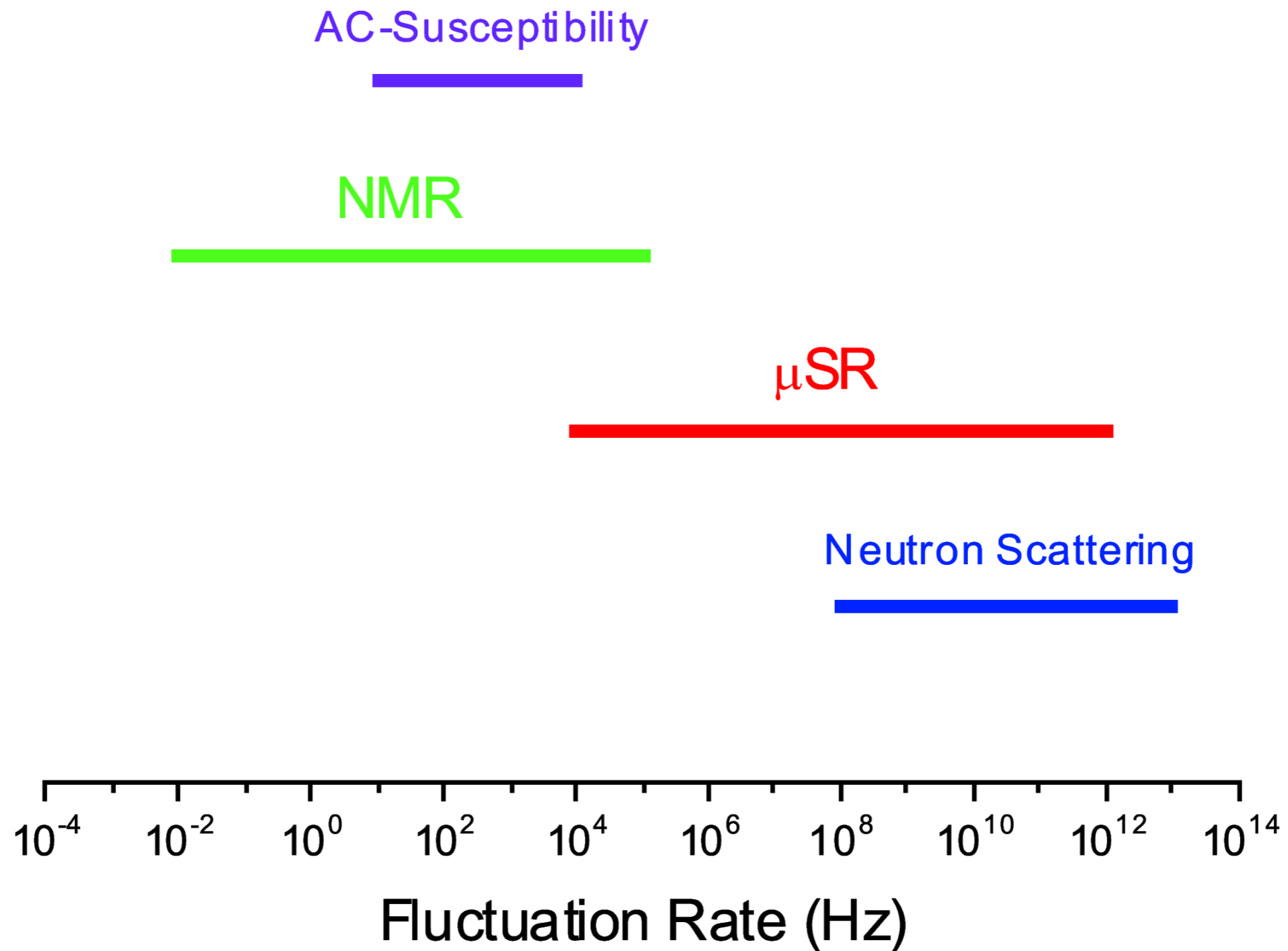

# Avoided Level-Crossing Resonance

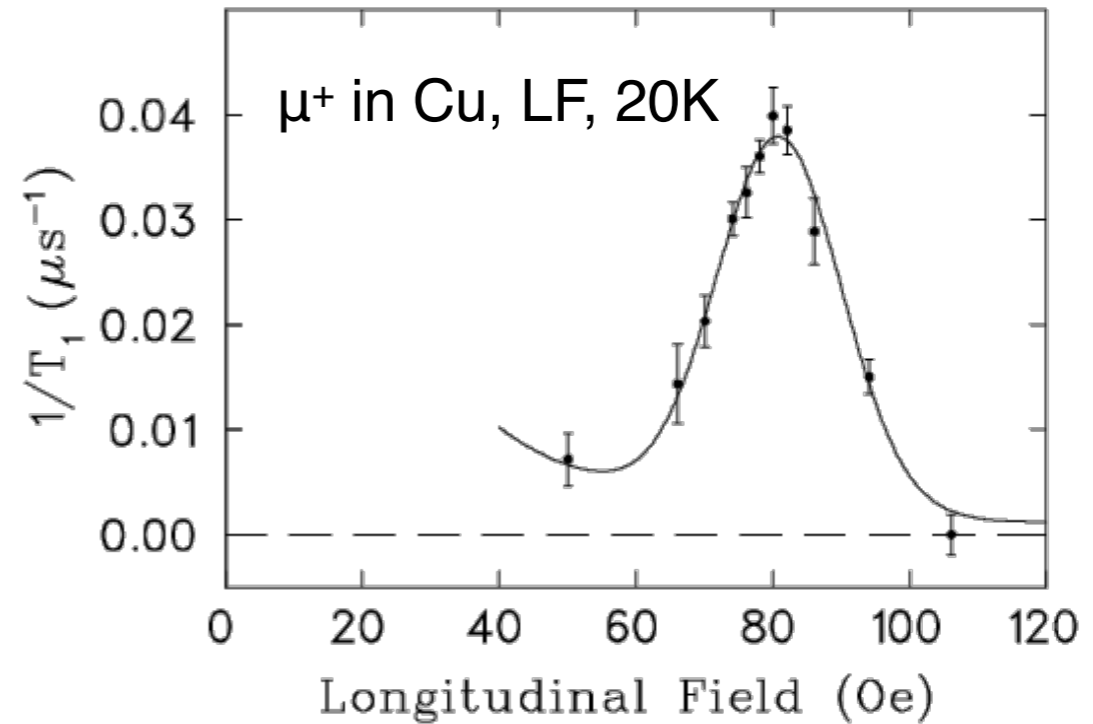
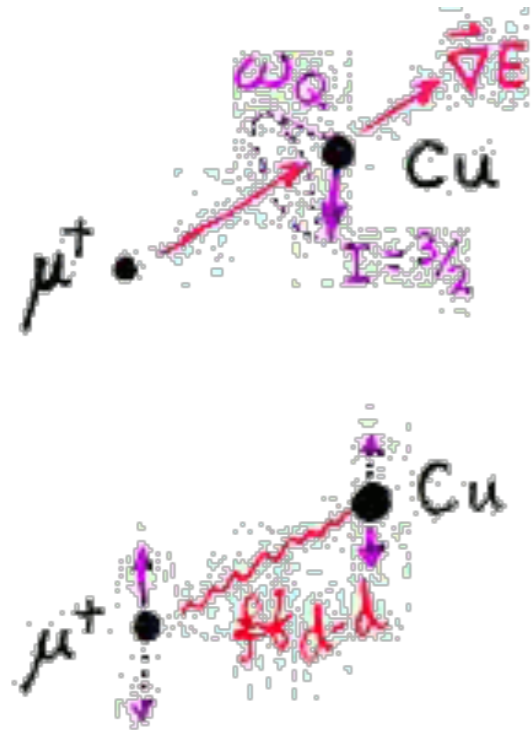

## Nuclear Quadrupolar version

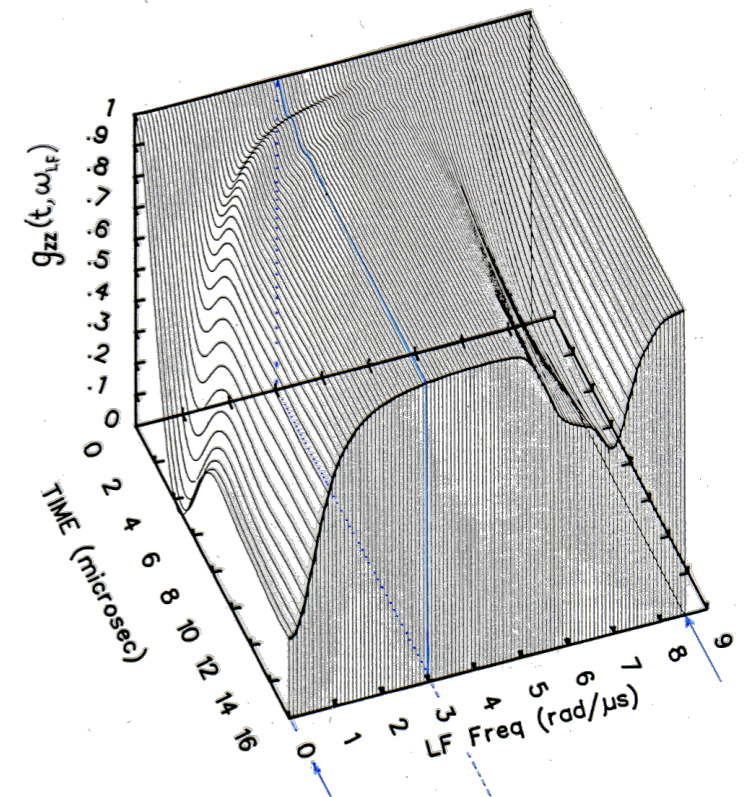
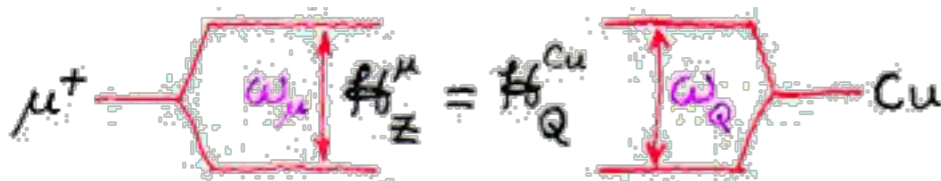
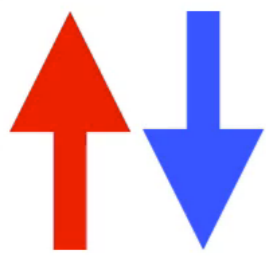

# Avoided Level-Crossing Resonance

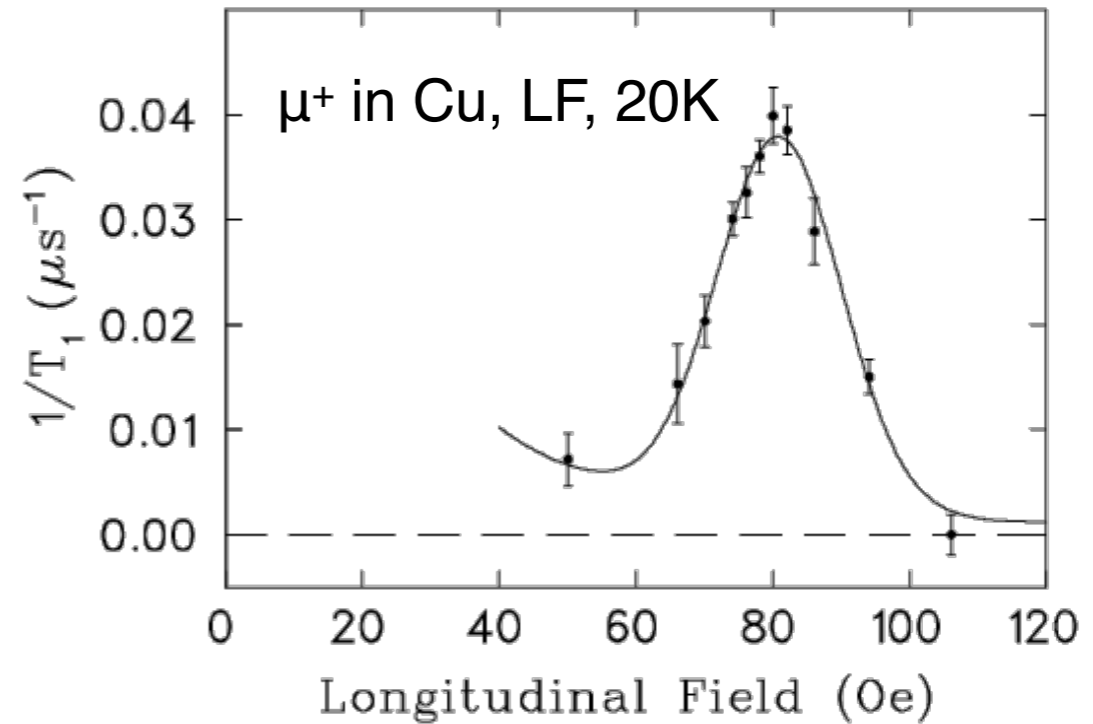
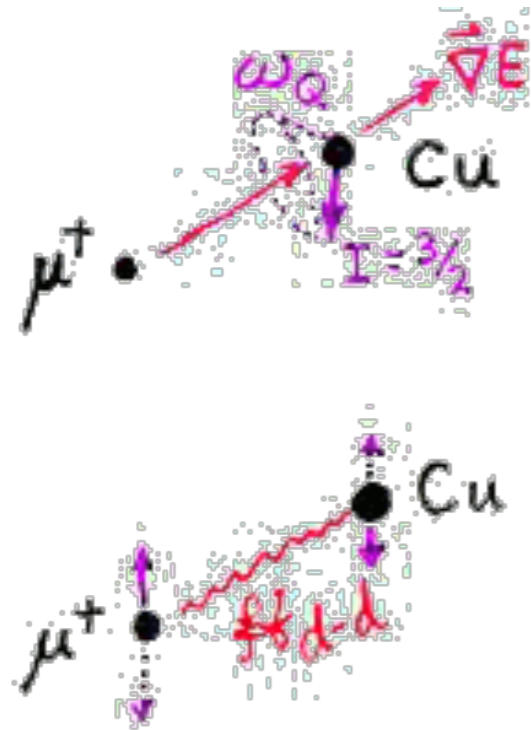

## Nuclear Quadrupolar version

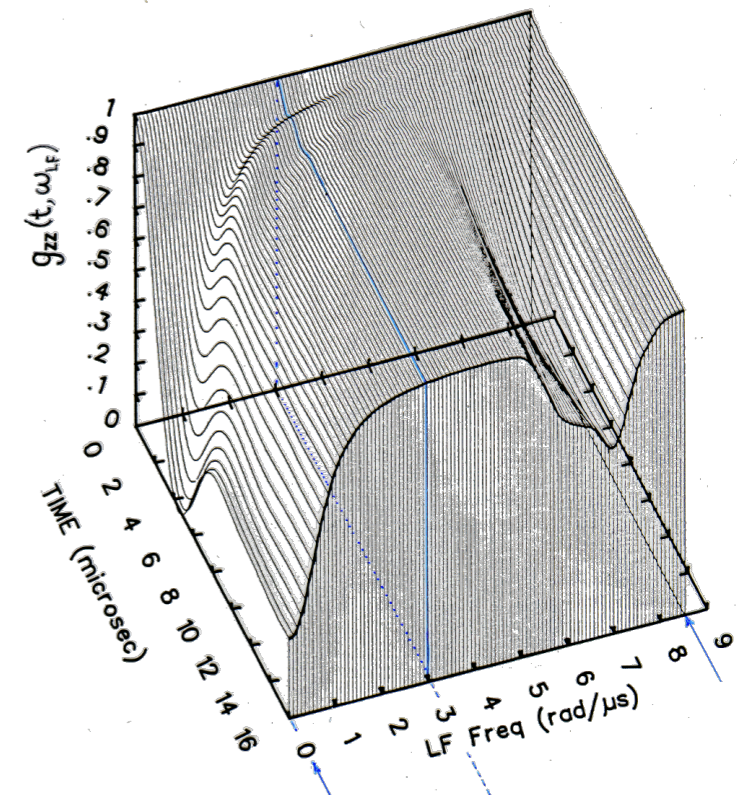
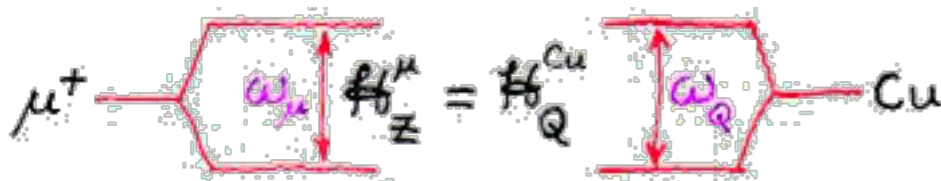
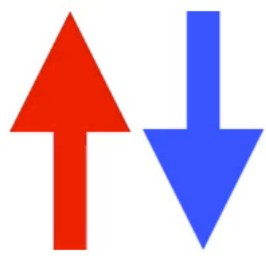

# Avoided Level-Crossing Resonance

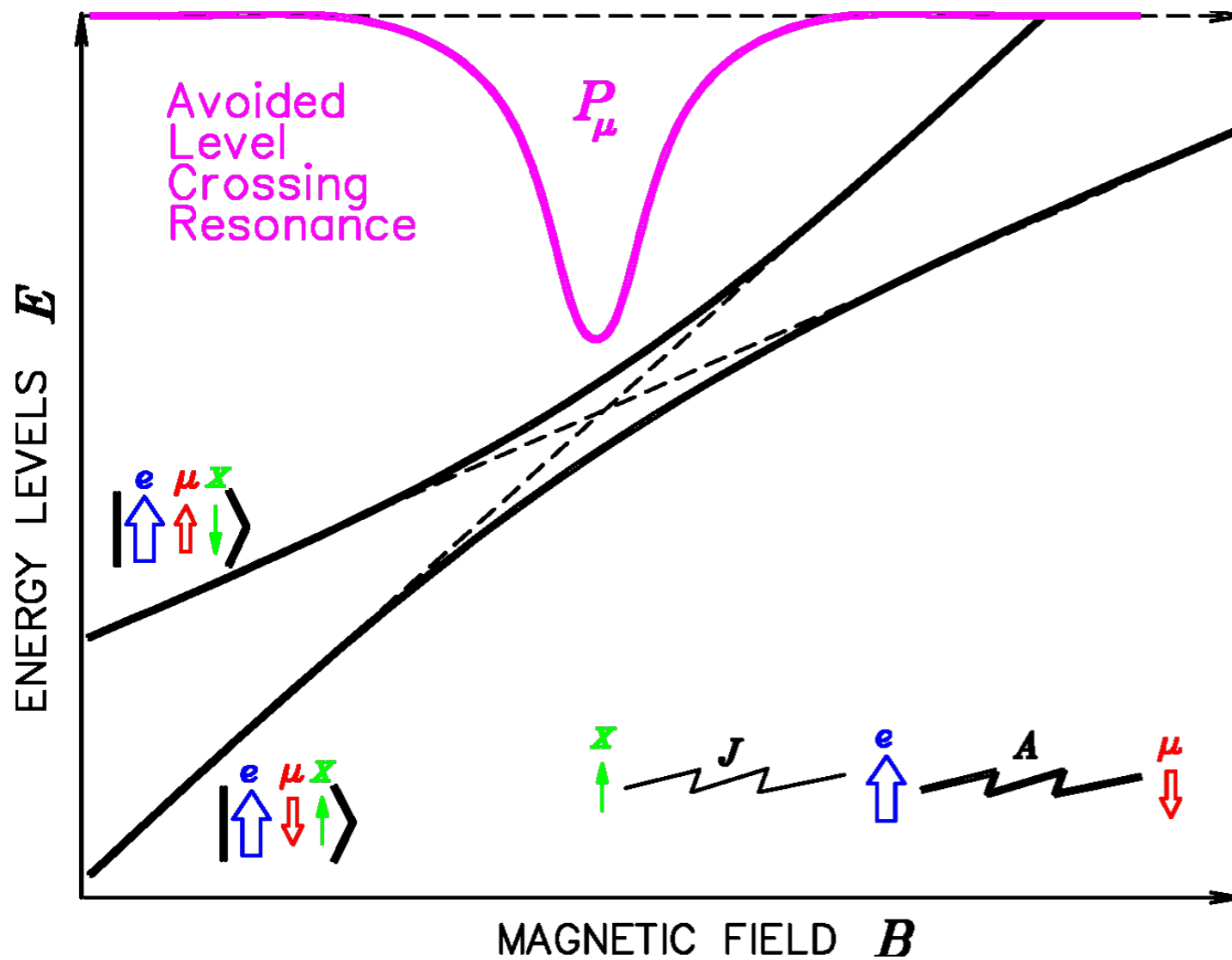

e.g. **CuCl** semiconductor

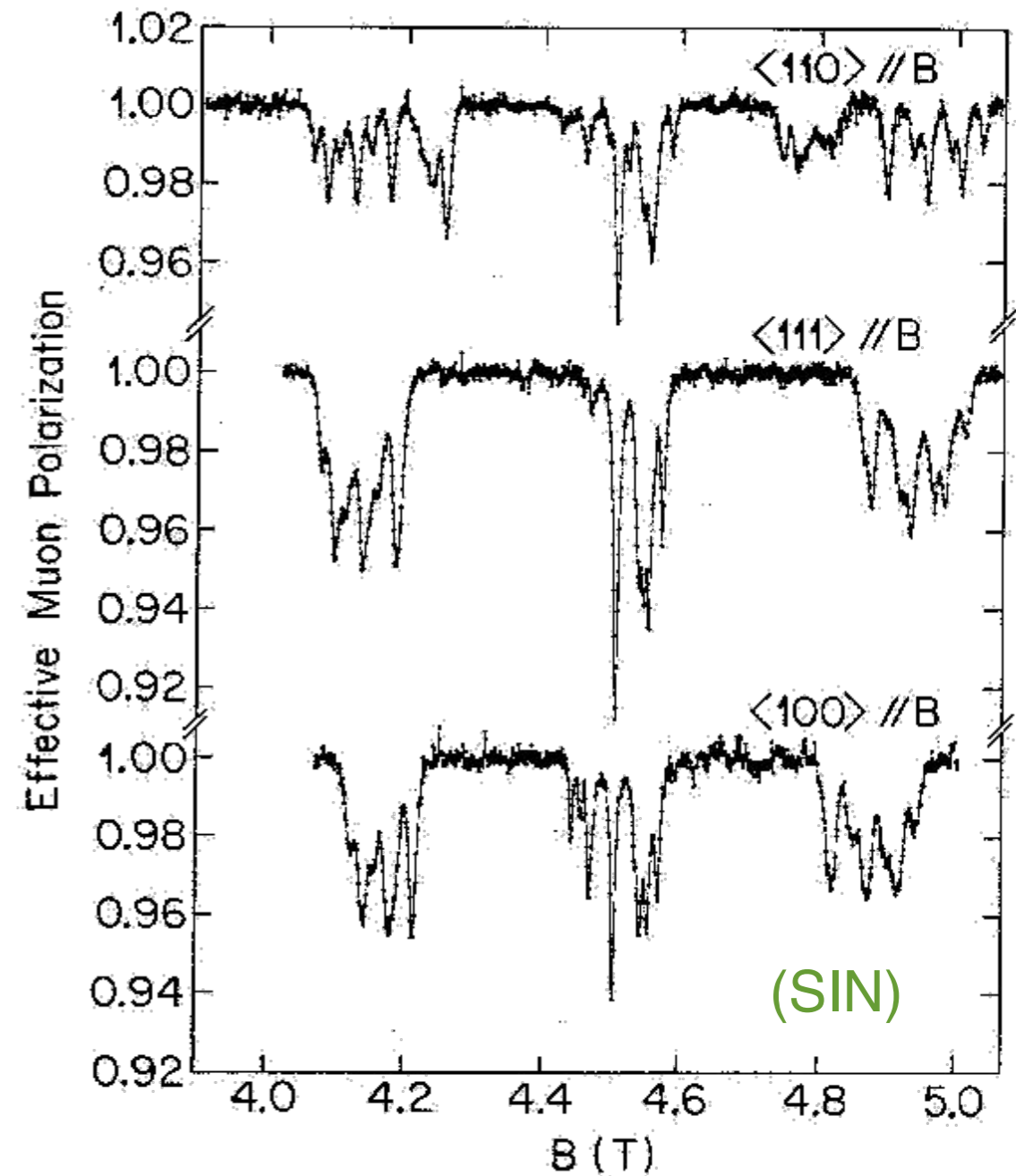

## Nuclear Hyperfine version



# Muonated Radicals

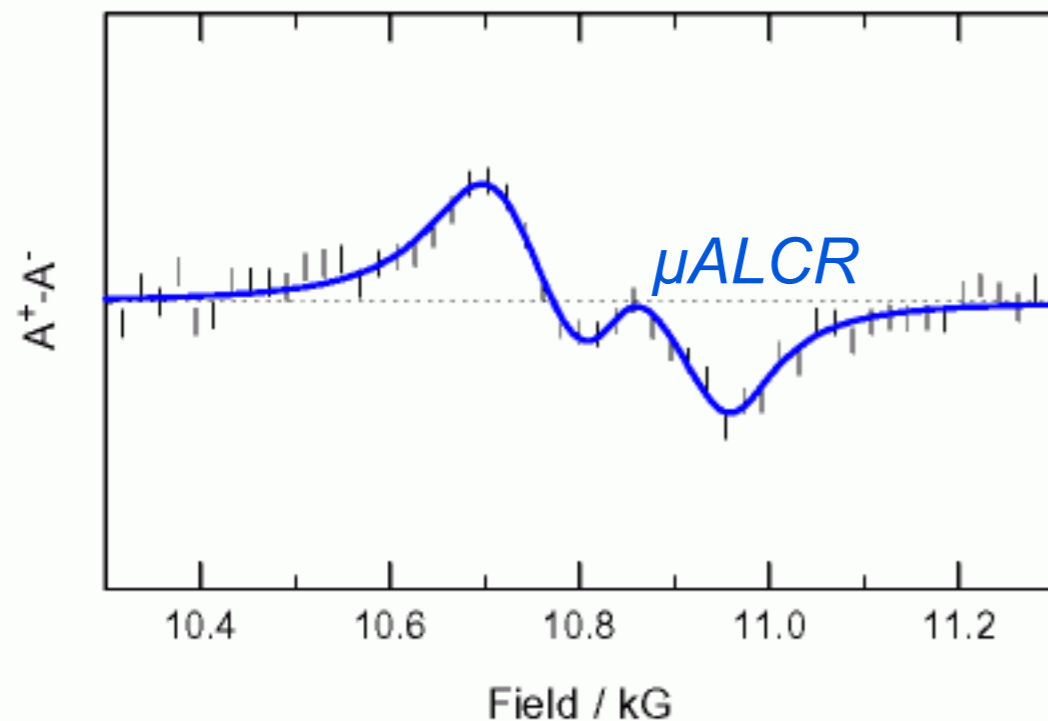
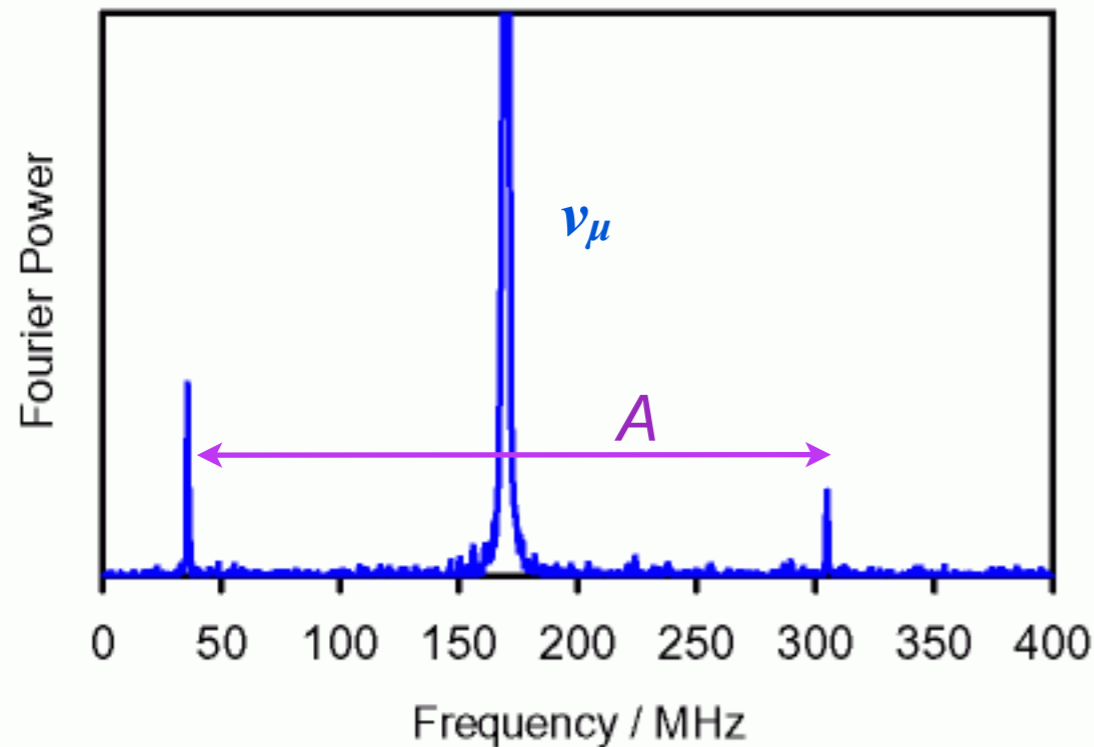

## Organic Free Radicals in Superheated Water

*Paul W. Percival, Jean-Claude Brodovitch, Khashayar Ghandi, Brett M. McCollum, and Iain McKenzie*

Apparatus has been developed to permit muon avoided level-crossing spectroscopy ( $\mu$ LCR) of organic free radicals in water at high temperatures and pressures. The combination of  $\mu$ LCR with transverse-field muon spin rotation (TF- $\mu$ SR) provides the means to identify and characterize free radicals via their nuclear hyperfine constants. Muon spin spectroscopy is currently the only technique capable of studying transient free radicals under hydrothermal conditions in an unambiguous manner, free from interference from other reaction intermediates. We have utilized the technique to investigate hydrothermal chemistry in two areas: dehydration of alcohols, and the enolization of acetone. Spectra have been recorded and hyperfine constants determined for the following free radicals in superheated water (typically 350°C at 250 bar): 2-propyl, 2-methyl-2-propyl (tert-butyl), and 2-hydroxy-2-propyl. The latter radical is the product of muonium addition to the enol form of acetone and is the subject of an earlier publication. The figure shows spectra for the **2-propyl** radical detected in an aqueous solution of 2-propanol at 350°C and 250 bar.

# RF- $\mu$ SR: muon Spin Resonance

Resonance at  $\omega_\mu$  shows fraction of muons in **diamagnetic** states such as  $\text{Mu}^+$  (= "bare"  $\mu^+$ ),  $\text{Mu}^-$  in various lattice sites even if it began as a paramagnetic state like  $\text{Mu}$ . Used to study formation and dissociation.

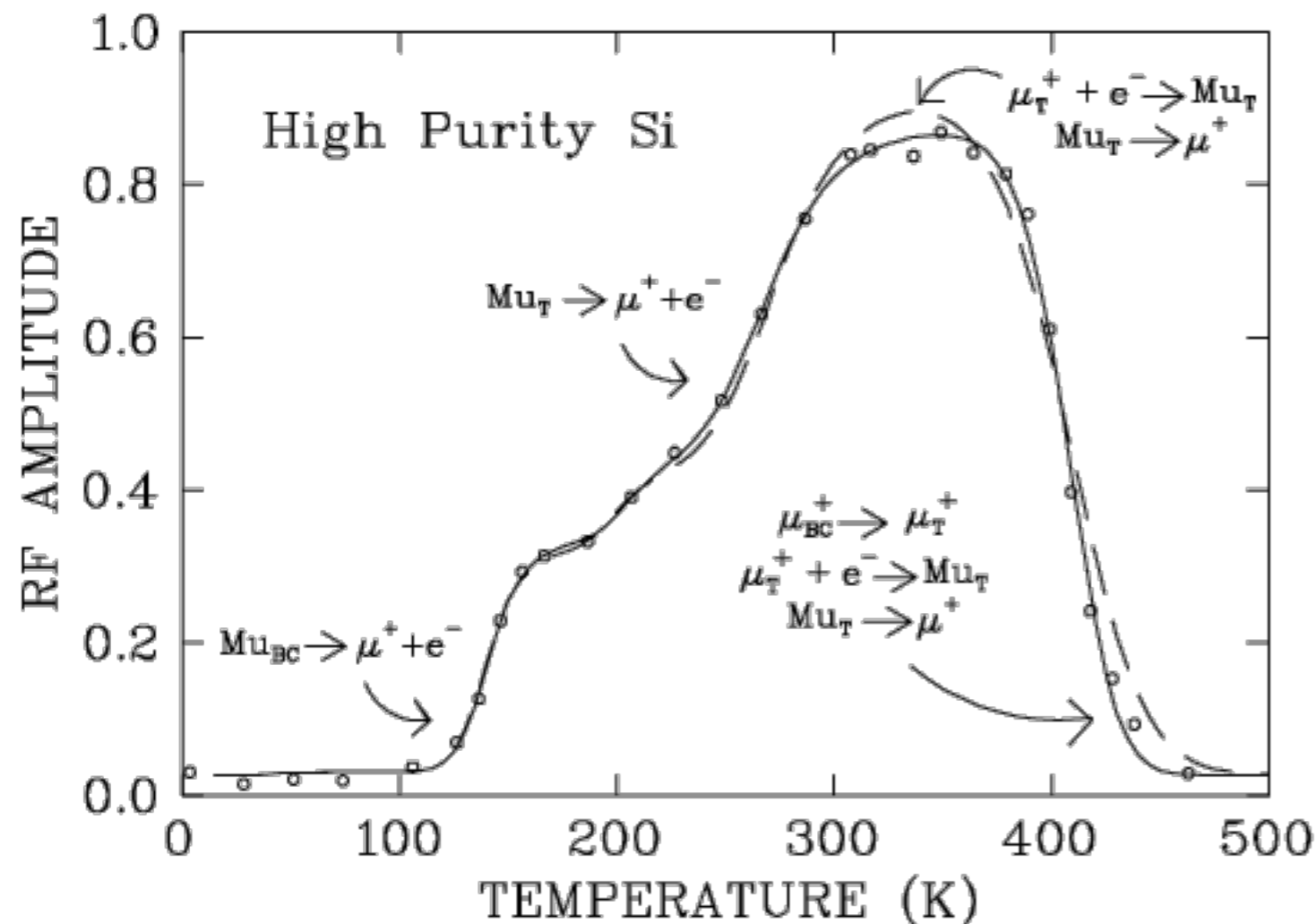
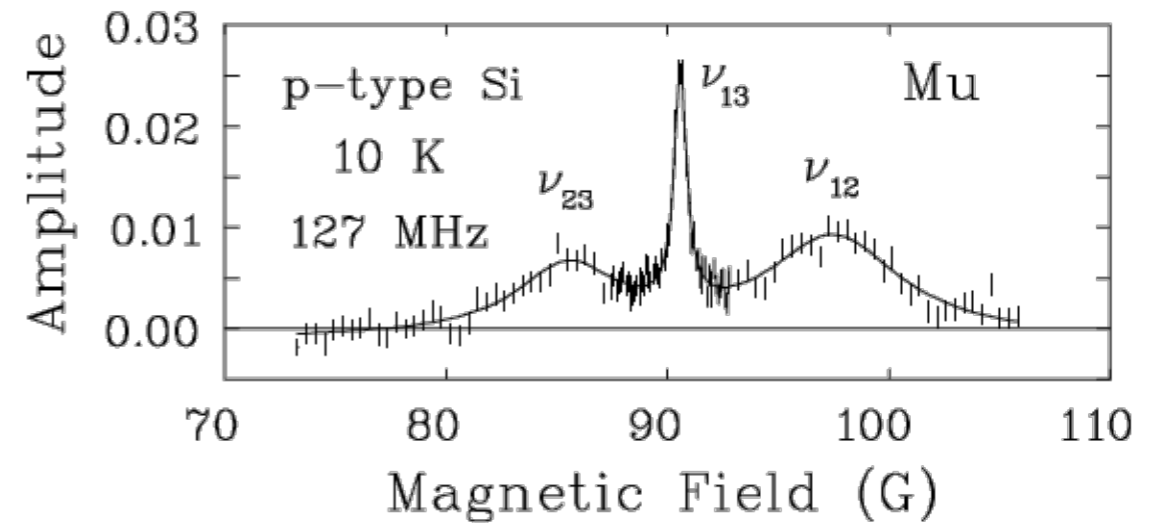

**Muonium** resonance at  $\omega_{ij}$  shows fraction of muons in **paramagnetic** states such as  $\text{Mu}$  itself or a *radical* (paramagnetic molecule). In the above case the field-sweep shows broad  $\omega_{12}$  and  $\omega_{23}$  resonances as well as a **sharp two-photon resonance** at their average.

# RF- $\mu$ SE: muon Spin Echo

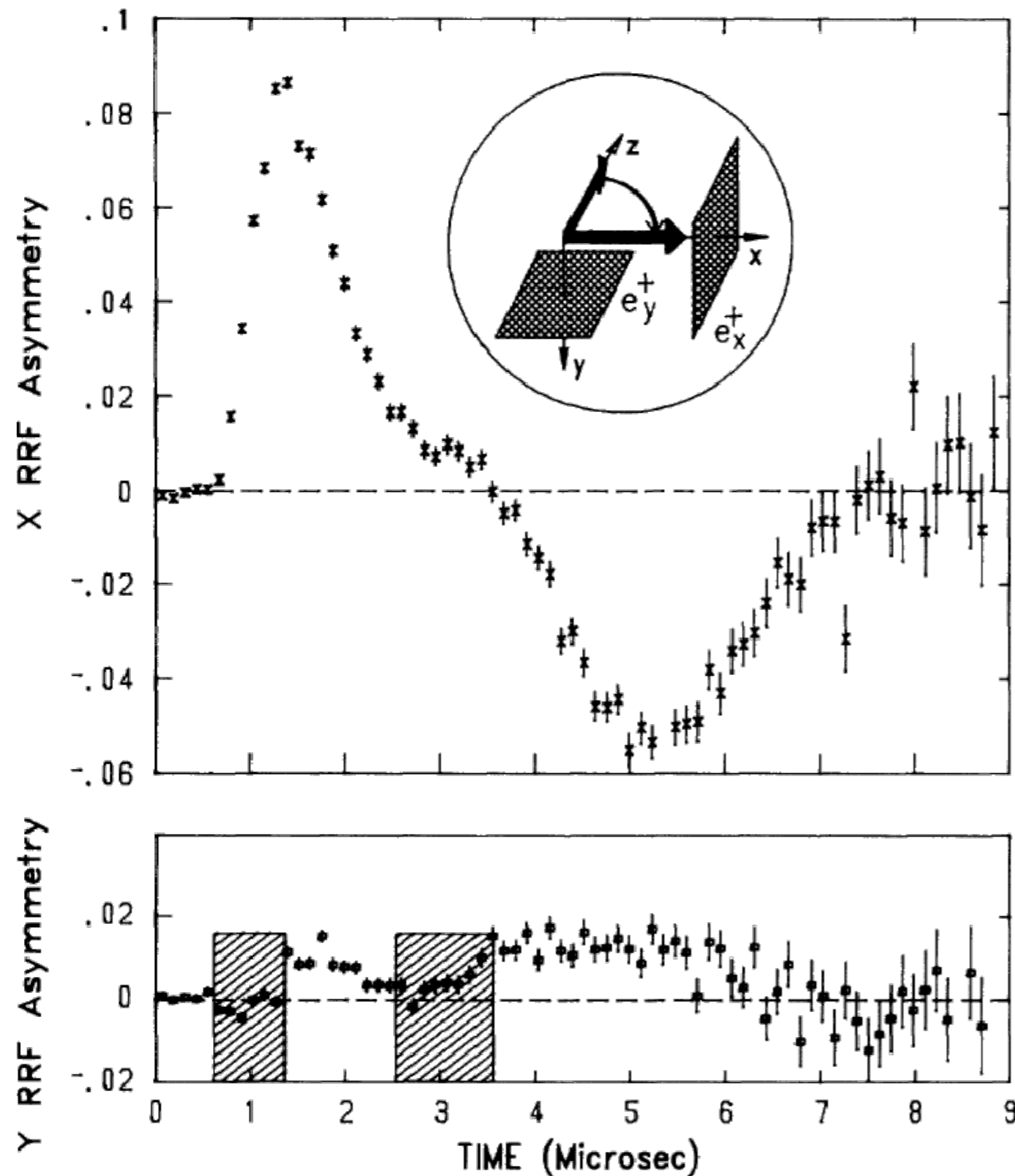

← **Direct  $\mu$ SE** in LaF3: muons enter with spins along  $B_0$ . A  $\pi/2$  RF pulse at  $\omega_\mu$  “flips them up” and they precess and “dephase”; a  $\pi$  pulse at time  $\tau$  makes them “refocus”.

**Indirect  $\mu$ SE**: muon spins initially  $\perp B_0$  are refocused by a  $\pi$  pulse on the  $^{19}\text{F}$  nuclei at frequency  $\omega_F$ . ↓

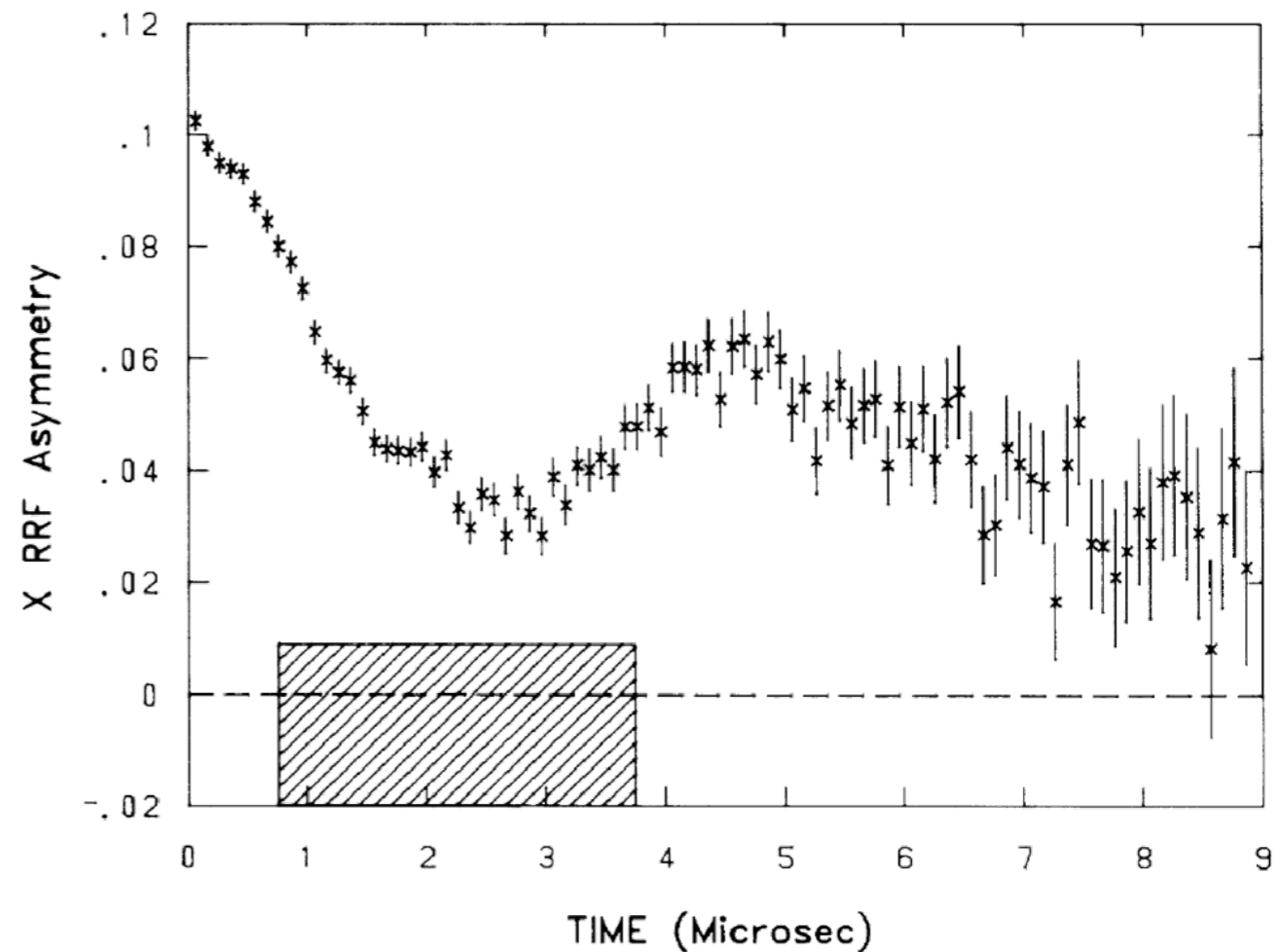

# $\mu SI$ : Muon Spin Imaging

“ $\mu$ ” cut from Al  
on depolarizing  
substrate:

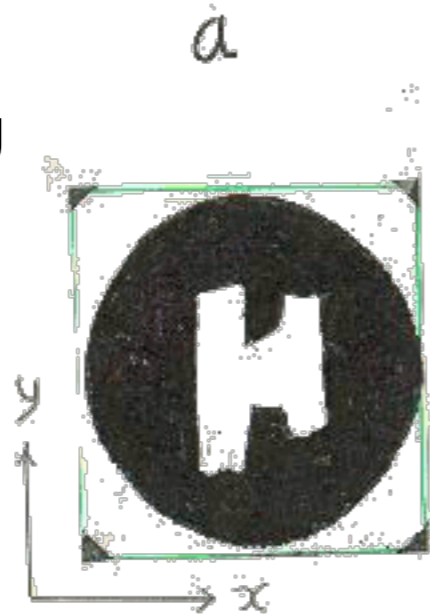

Magnetic field gradients applied in  
many directions; each spectrum  
Fourier transformed to translate  
frequency into spatial coordinates;  
all combined to form image:

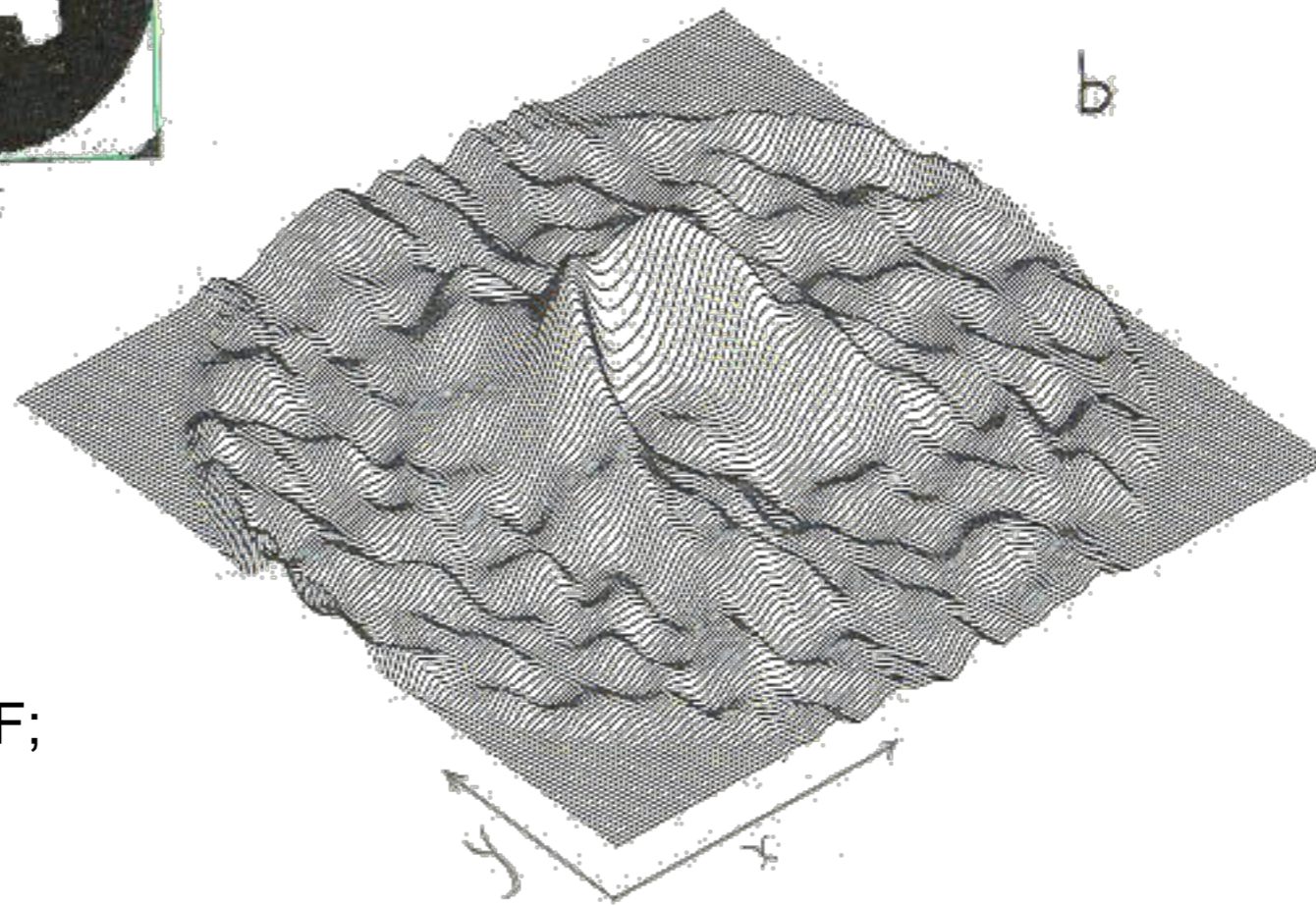

Deemed impractical at TRIUMF;  
but with RF & gradient pulse  
sequences at a high intensity  
pulsed facility, who knows...?

N. Kaplan *et al.*, *Hyperfine Int.* **85**, 271 (1994)

Finis

# $\mu$ SR Acronyms

Transverse  
Field

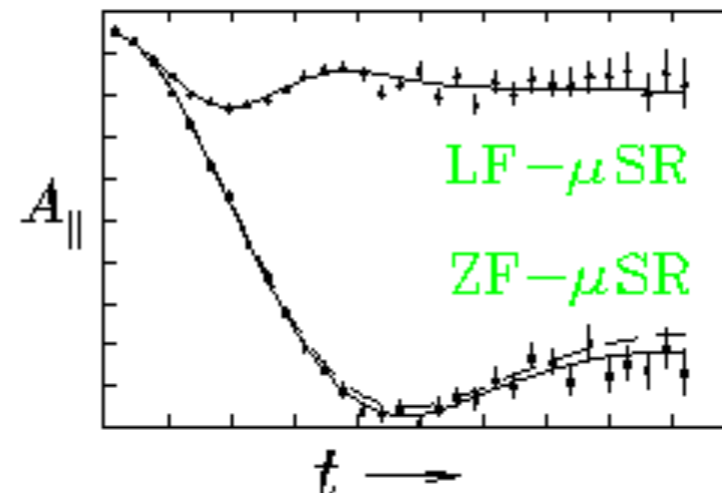
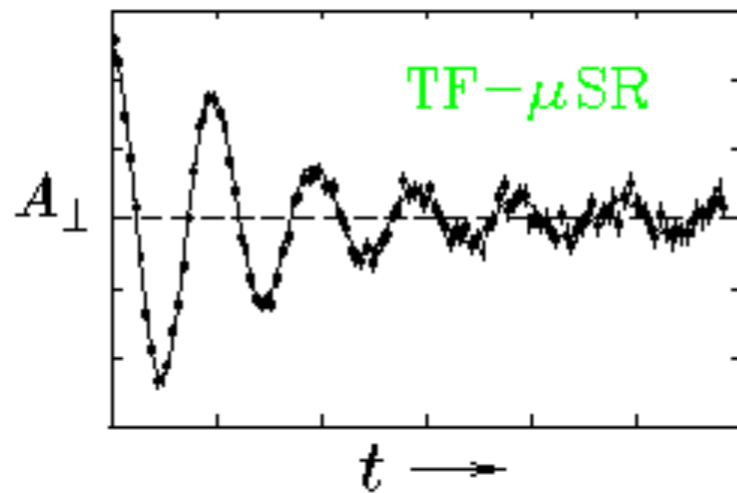

Longitudinal  
Field

Zero Field

Fourier  
Transform  
 $\mu$ SR

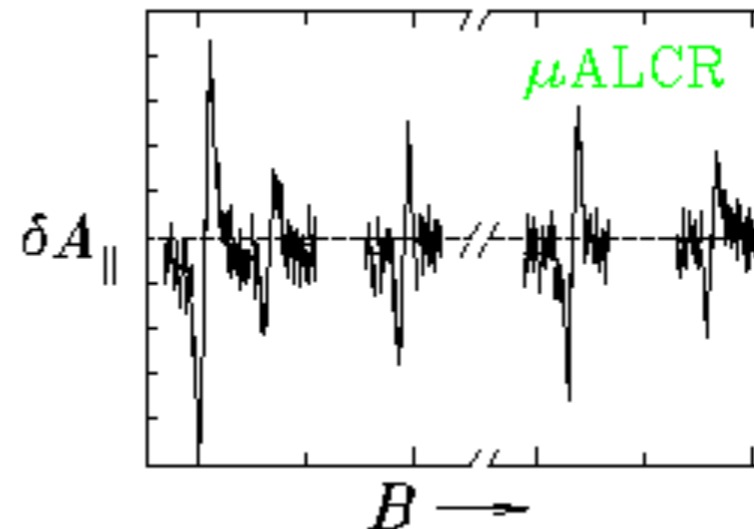
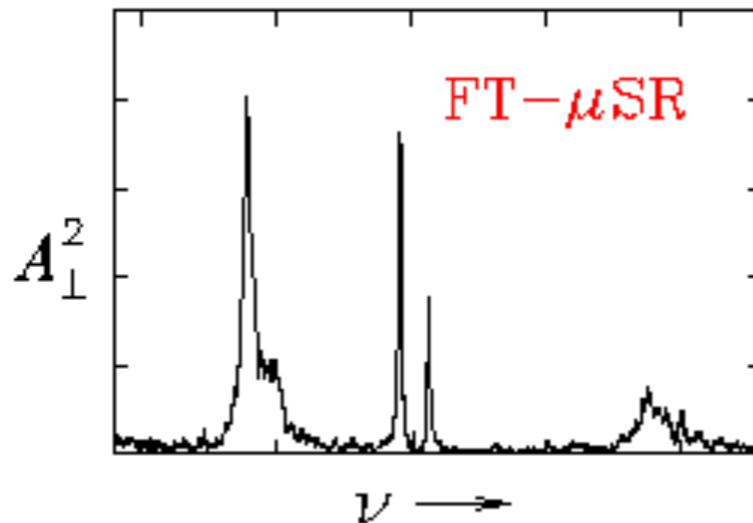

Avoided  
Level  
Crossing  
Resonance

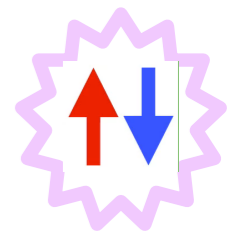

Muon  
Spin  
Resonance

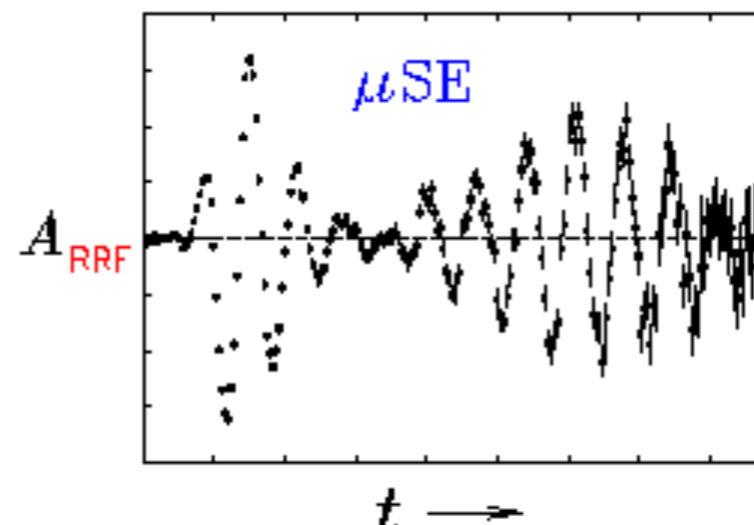
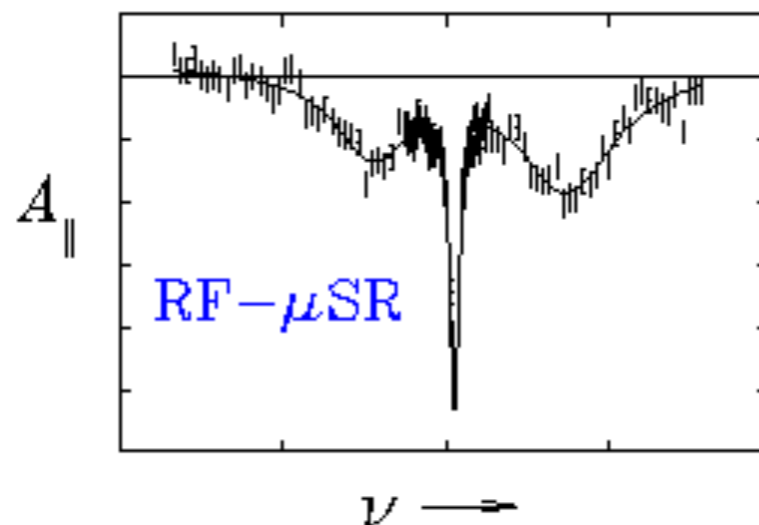

Muon  
Spin  
Echo

# $\mu$ SR Acronyms

Transverse  
Field

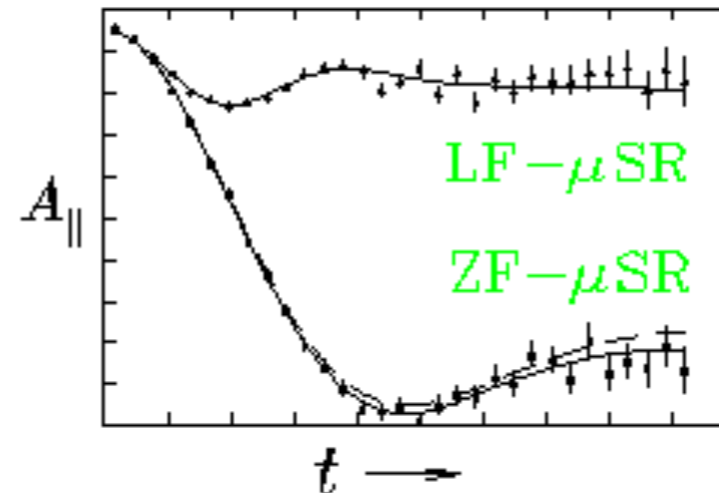
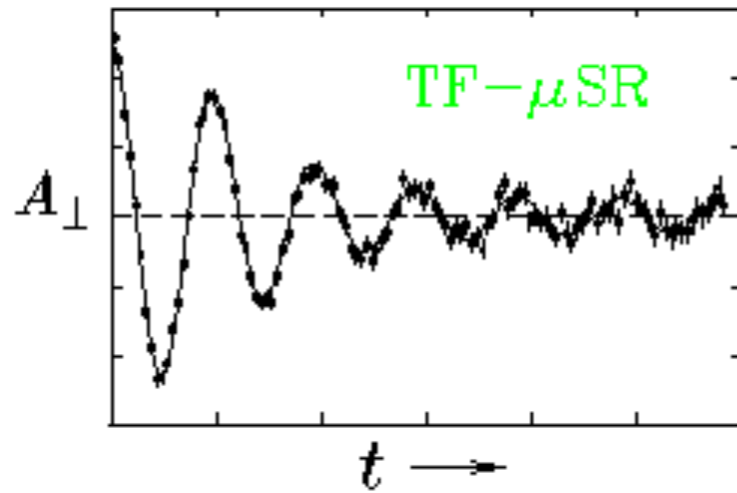

Longitudinal  
Field  
Zero Field

Fourier  
Transform  
 $\mu$ SR

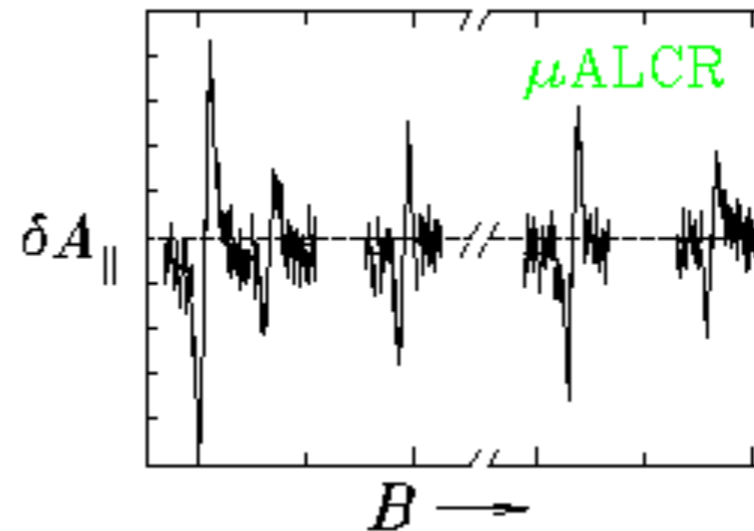
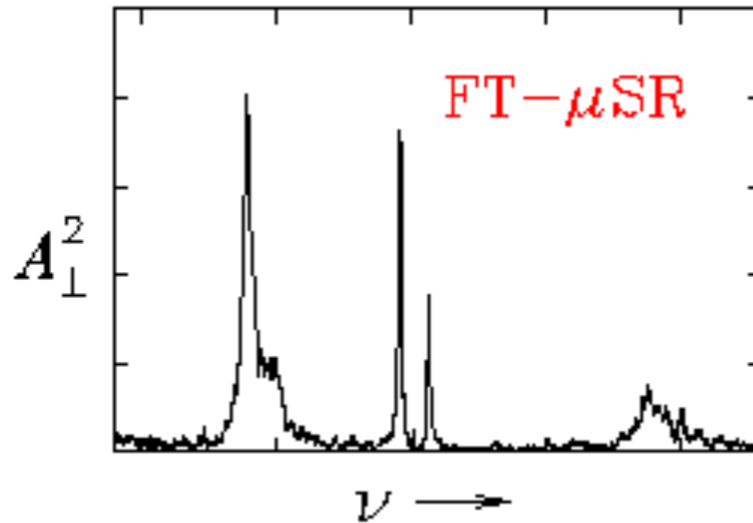

Avoided  
Level  
Crossing  
Resonance

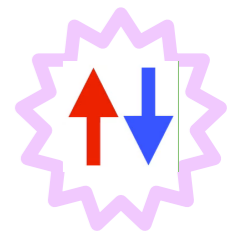

Muon  
Spin  
Resonance

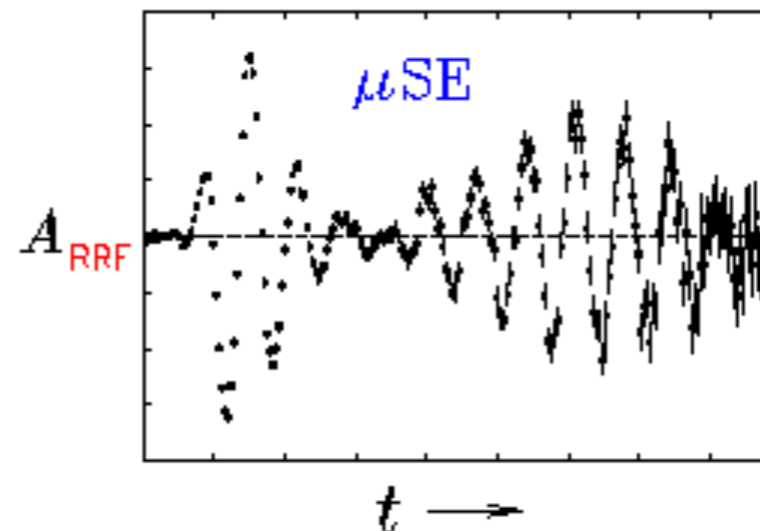
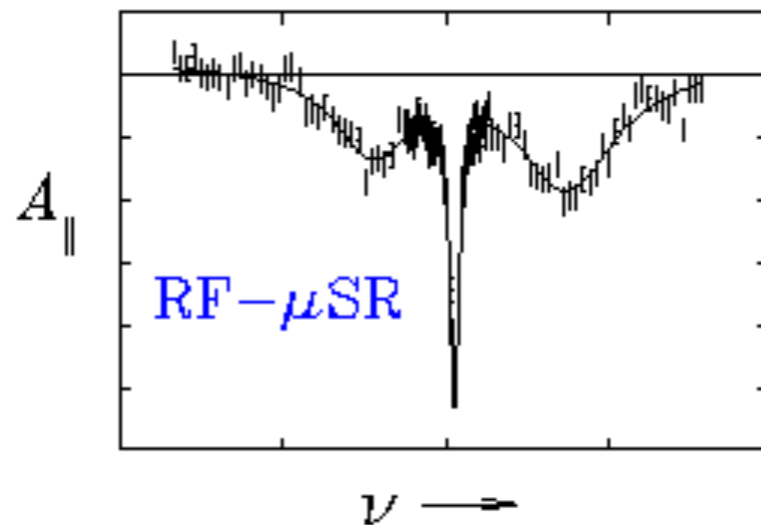

Muon  
Spin  
Echo

# Coordinate Conventions

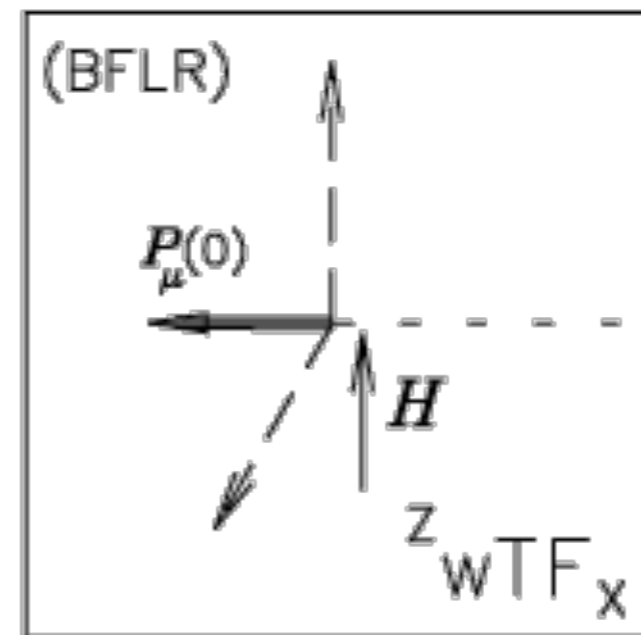
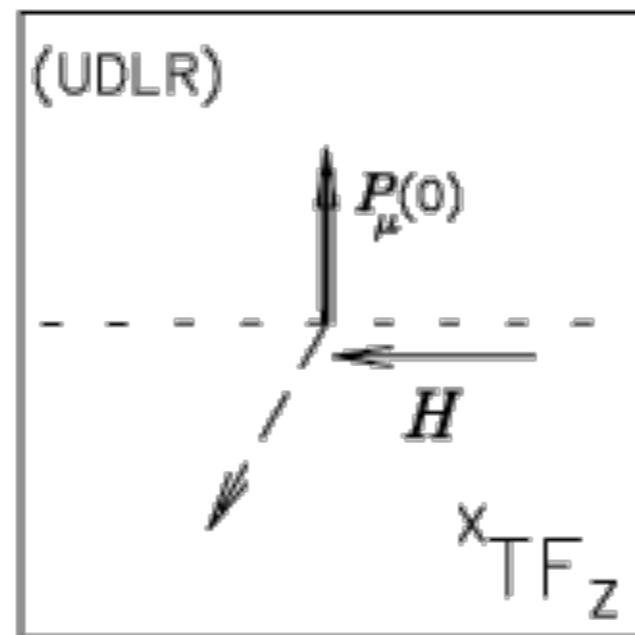
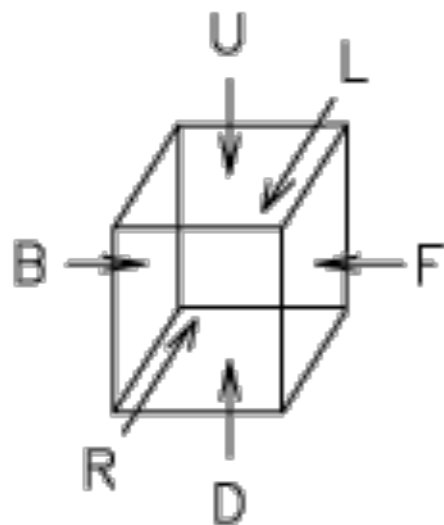
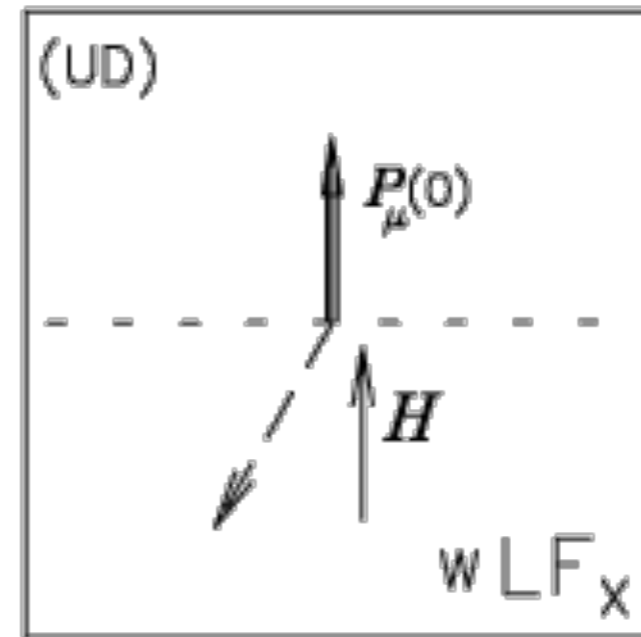
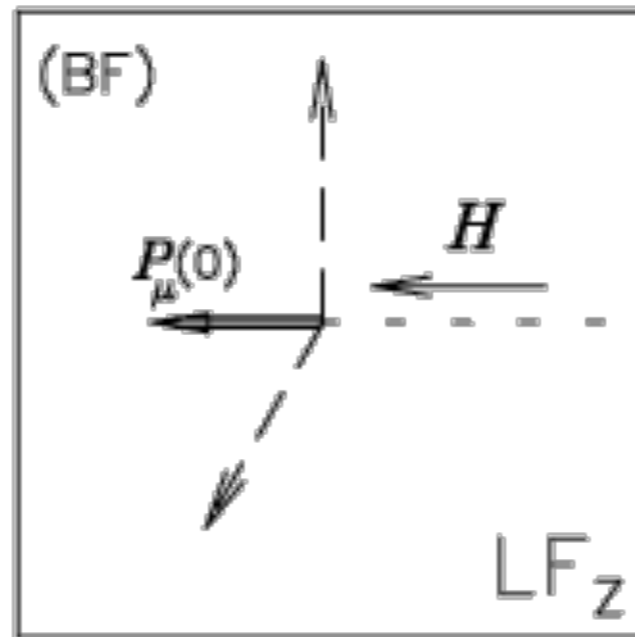
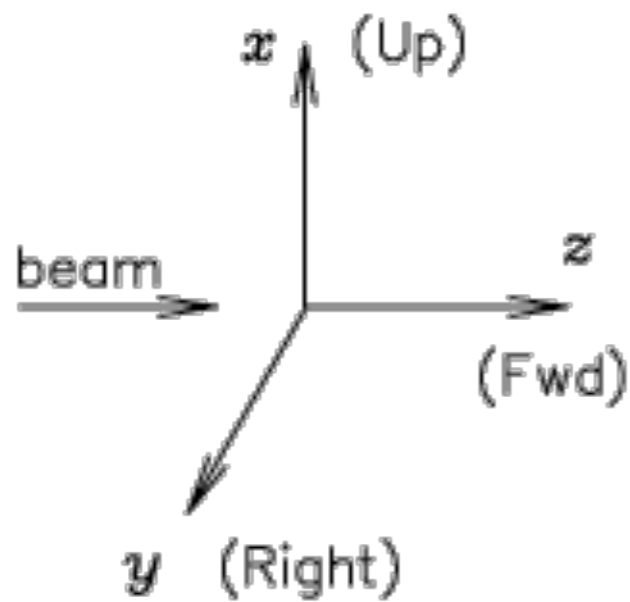



# Rotating Reference Frame

Muon spin precession in high transverse field (**HTF- $\mu$ SR**) requires progressively smaller time bins to record the oscillations. These smaller bins capture fewer counts (lower statistics) and require more calculations for fitting. Worse yet, the essential characteristics of the data are not readily observed “by eye”.

Fortunately, it is easy to convert the asymmetry spectrum into a Rotating Reference Frame (**RRF**) after the fact.

$$\mathcal{A}_{\text{LAB}}(t) = A_x(t) + iA_y(t)$$

$$\mathcal{A}_{\text{RRF}}(\Omega, t) = e^{-i\Omega t} \mathcal{A}_{\text{LAB}}(t)$$

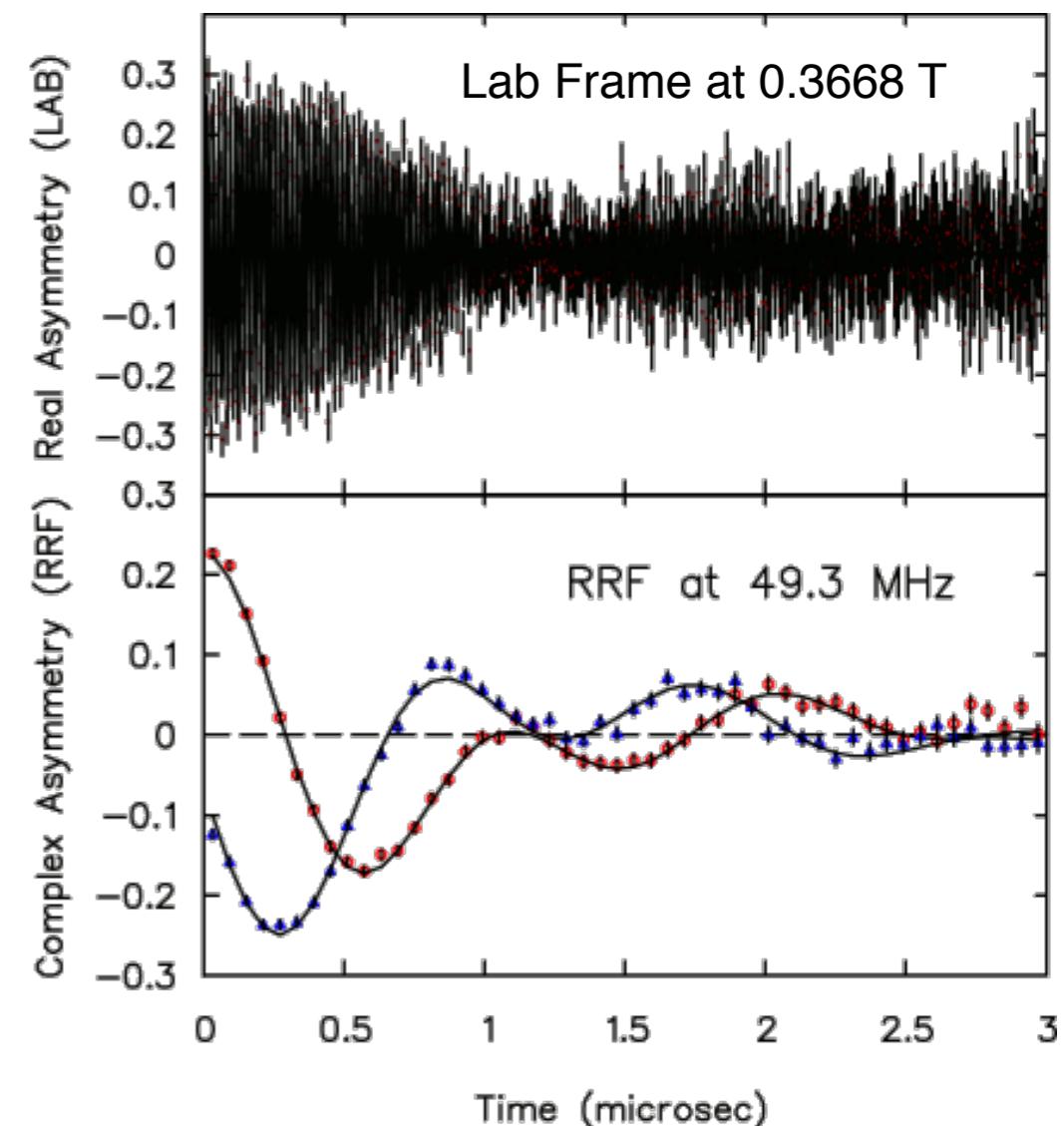
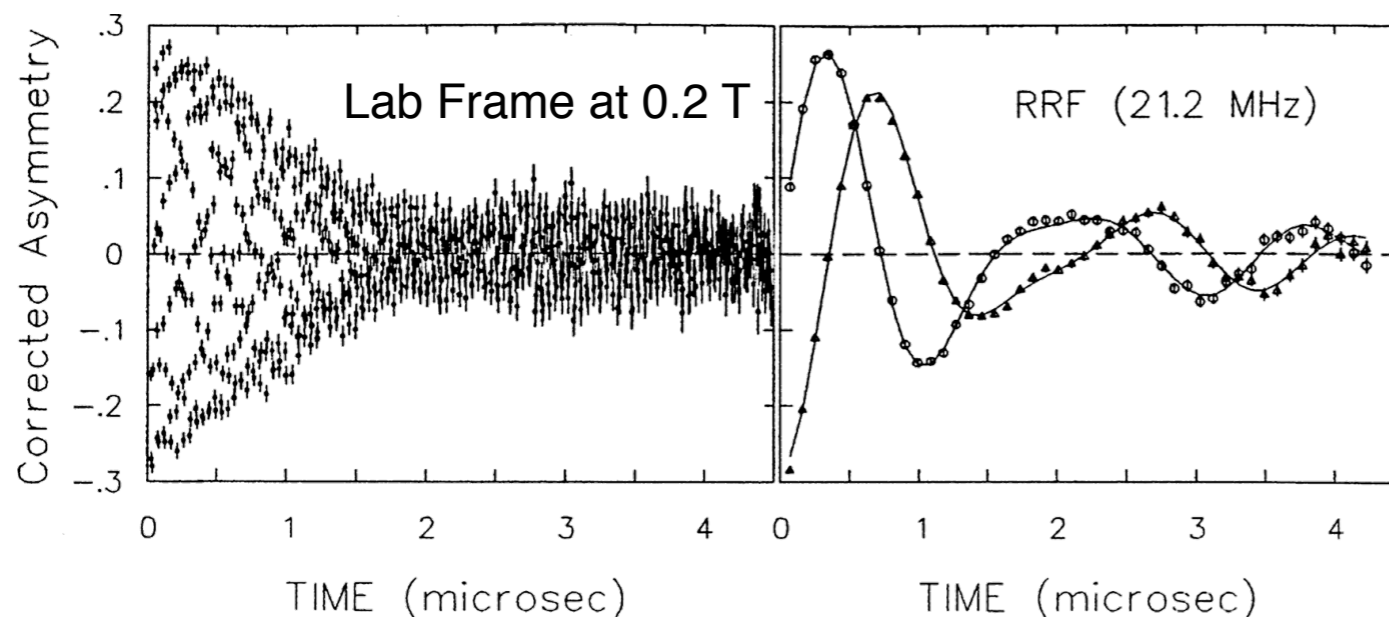

# Stroboscopic $\mu SR$

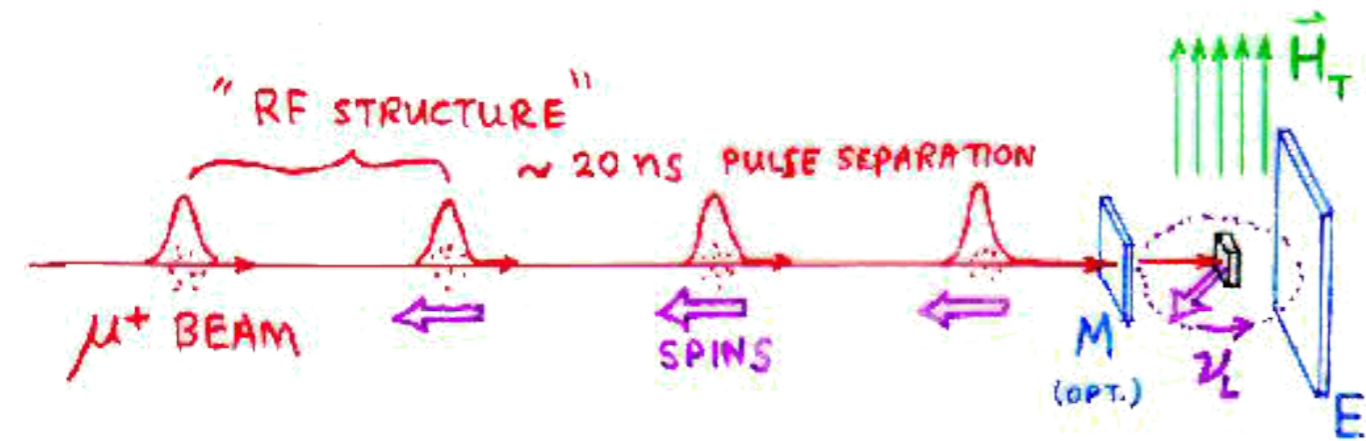

WHEN  $1/\nu_L$  (PRECESSION PERIOD) IS

$1/n \times$  INTERVAL BETWEEN MUON PULSES,  
 $\uparrow$  integer ( $\sim 1$  or  $2$ )

ALL MUONS ARRIVE "IN PHASE" AND  
 GATED COUNT RATE [AT APPROPRIATE TIME RELATIVE  
 TO PULSE ARRIVAL] IS MAXIMIZED.

$$2\pi \nu_L = \gamma_{\mu} H_T$$

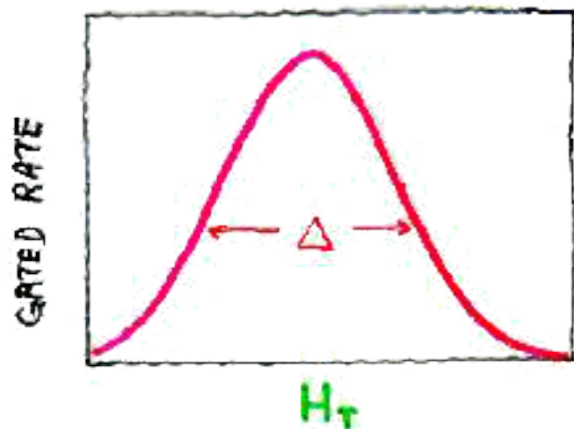

- NO RATE LIMIT!  
 (MANY MUONS IN TARGET)
- Gives KNIGHT SHIFTS to  $\sim 1$  ppm
- PROBLEM: INTRINSIC WIDTH
- $\Delta = \frac{1}{\tau_{\mu}} = 0.454 \mu s^{-1}$

STROBOSCOPIC SIGNALS

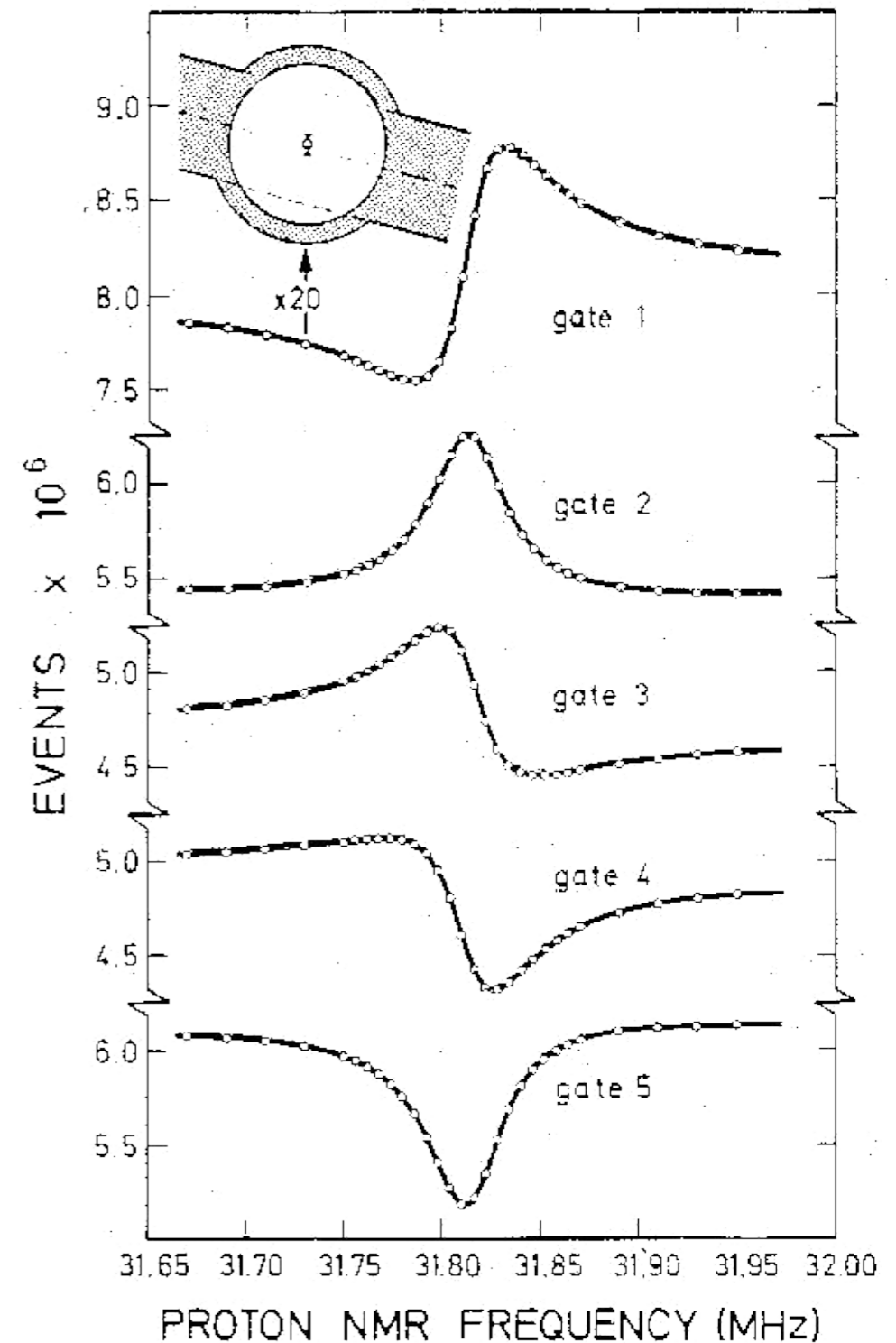

# Stroboscopic $\mu SR$

Schenck et al. - SIN

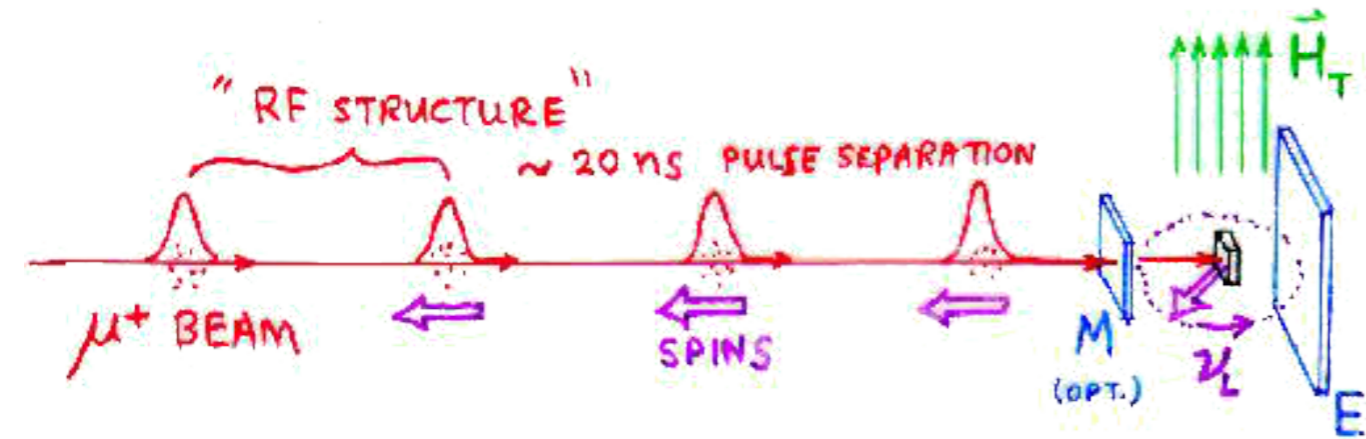

WHEN  $1/\nu_L$  (PRECESSION PERIOD) IS

$1/n \times$  INTERVAL BETWEEN MUON PULSES,  
 $\uparrow$  integer ( $\sim 1$  or  $2$ )

ALL MUONS ARRIVE "IN PHASE" AND  
 GATED COUNT RATE [AT APPROPRIATE TIME RELATIVE  
 TO PULSE ARRIVAL] IS MAXIMIZED.

$$2\pi \nu_L = \gamma_\mu H_T$$

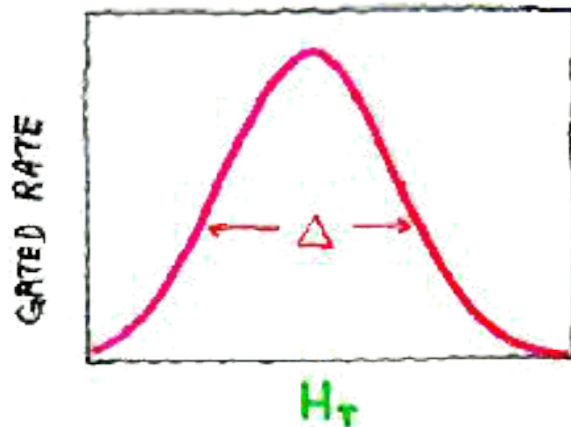

- NO RATE LIMIT!  
 (MANY MUONS IN TARGET)
- Gives KNIGHT SHIFTS to  $\sim 1$  ppm
- PROBLEM: INTRINSIC WIDTH
- $\Delta = \frac{1}{\tau_\mu} = 0.454 \mu s^{-1}$

## STROBOSCOPIC SIGNALS

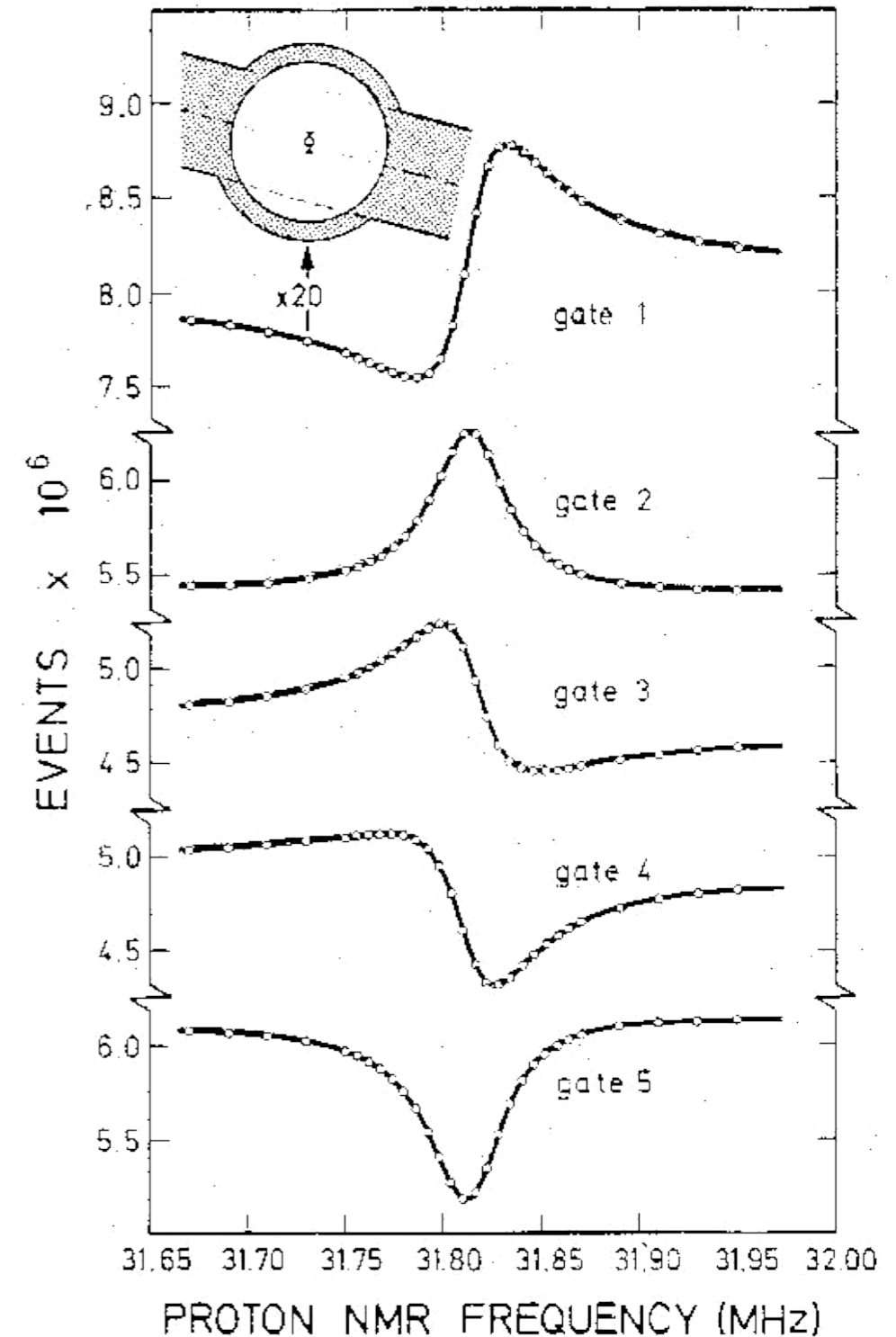

# Muonium ( $\text{Mu} \equiv \mu^+ e^-$ ) and FFT Spectroscopy

In a  $\mu\text{SR}$  experiment one measures a time spectrum at a given field and extracts *all* frequencies via FFT.

**Breit-Rabi diagram**

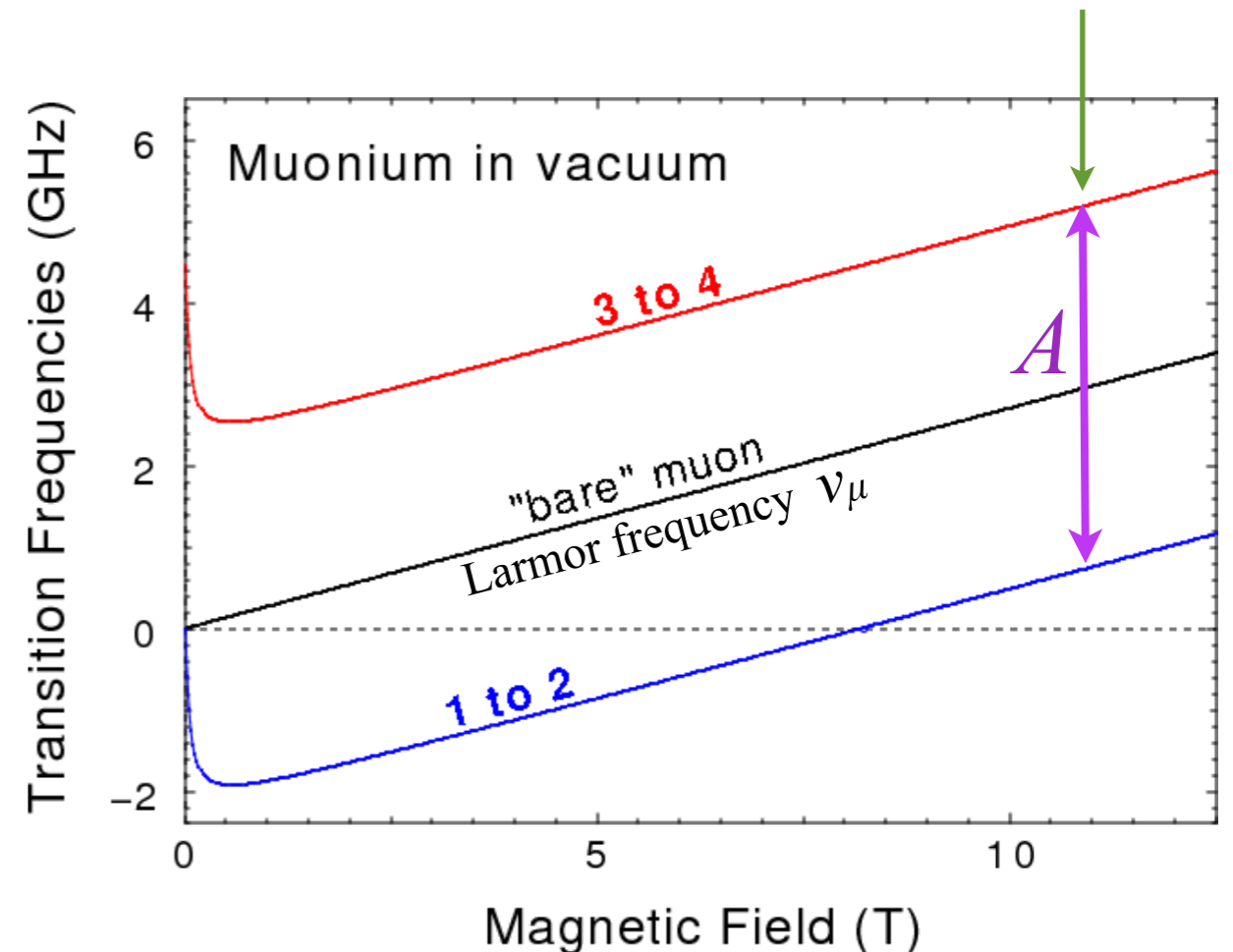
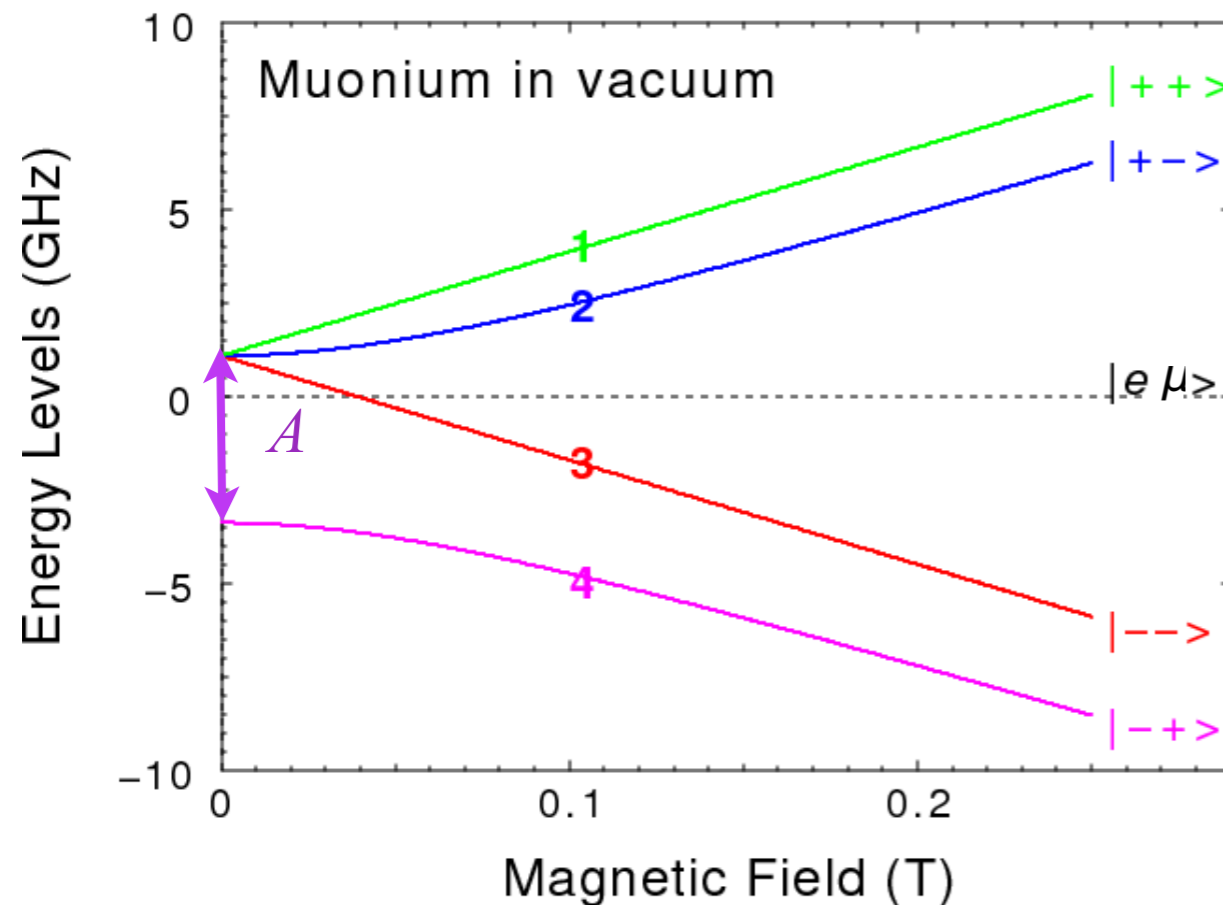

“**Signature**” of **Mu** (or other hyperfine-coupled  $\mu^+ e^-$  spin states) in **high transverse field**: *two frequencies centred on  $\nu_\mu$  and separated by the hyperfine splitting  $A \propto r^{-3}$ .*

# Motion of Muon Spins in Static Local Fields

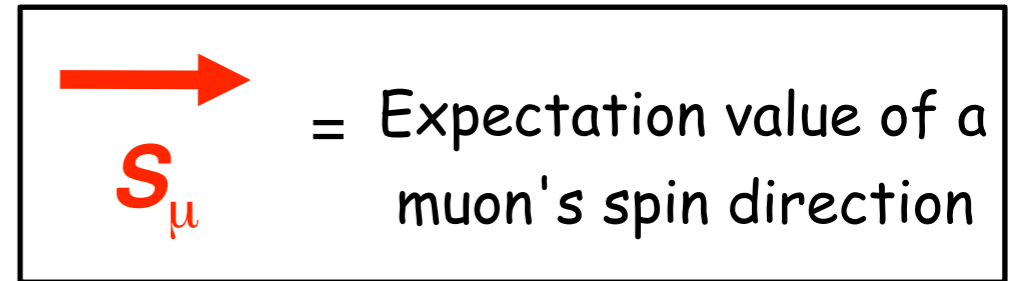

(a) All muons "see" same field  $\mathbf{B}$ : for  $\mathbf{B} \parallel \mathbf{S}_\mu$  nothing happens

$$\omega_\mu = 2\pi \gamma_\mu |\mathbf{B}|$$

$$\gamma_\mu = 135.5 \text{ MHz/T}$$

for  $\mathbf{B} \perp \mathbf{S}_\mu$  Larmor precession:

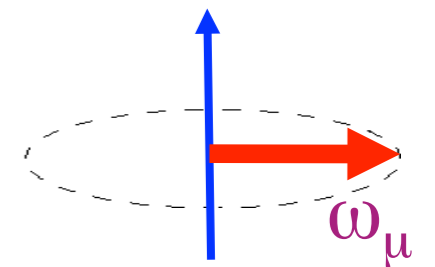

(b) All muons "see" same  $|\mathbf{B}|$  but **random direction**:

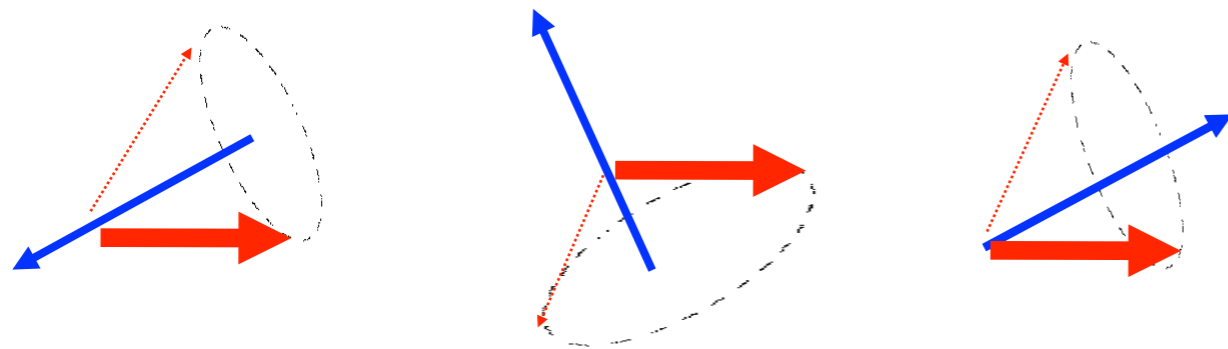

$2/3$  of  $\mathbf{S}_\mu$  precesses at  $\omega_\mu$

$1/3$  of  $\mathbf{S}_\mu$  stays constant

(c) Local field  $\mathbf{B}$  **random** in **both magnitude and direction**:

All do not return to the same orientation at the same time  
(dephasing)  $\Rightarrow \mathbf{S}_\mu$  "relaxes" as  $G_{zz}(t)$  [Kubo & Toyabe, 1960's]

# Motion of Muon Spins in Static Local Fields

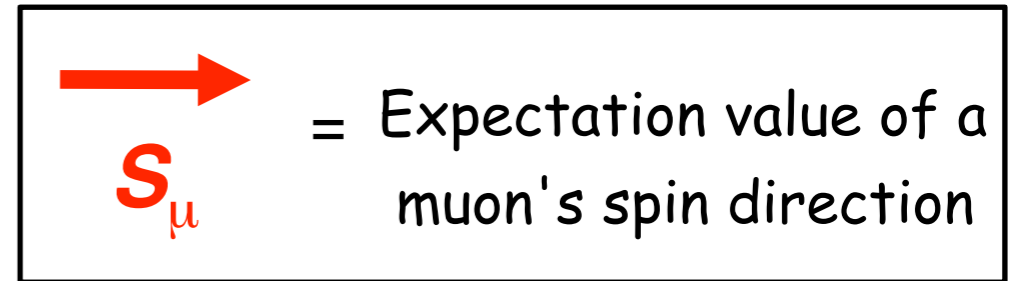

(a) All muons "see" same field  $\mathbf{B}$ : for  $\mathbf{B} \parallel \mathbf{S}_\mu$  nothing happens

$$\omega_\mu = 2\pi \gamma_\mu |\mathbf{B}|$$

$$\gamma_\mu = 135.5 \text{ MHz/T}$$

for  $\mathbf{B} \perp \mathbf{S}_\mu$  Larmor precession:

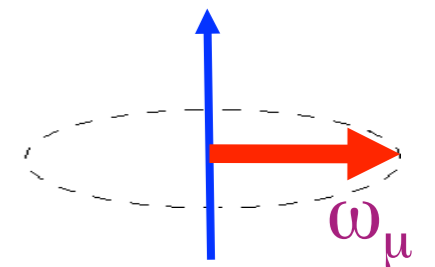

(b) All muons "see" same  $|\mathbf{B}|$  but **random direction**:

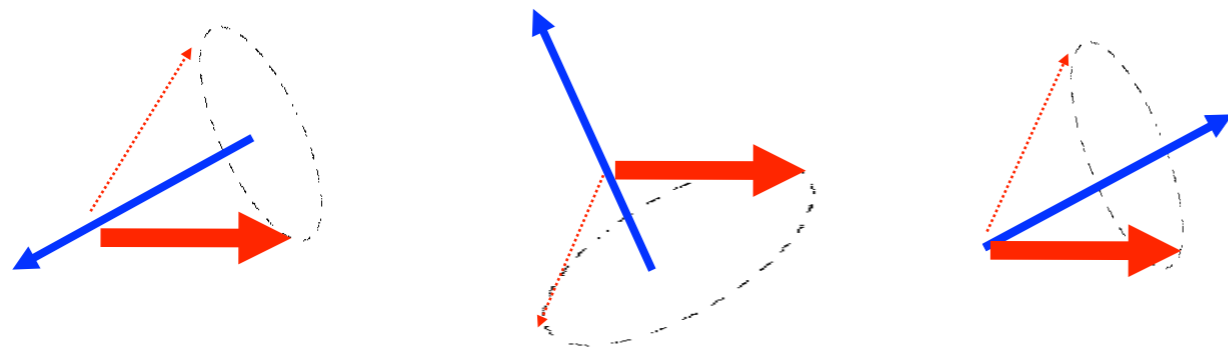

$2/3$  of  $\mathbf{S}_\mu$  precesses at  $\omega_\mu$

$1/3$  of  $\mathbf{S}_\mu$  stays constant

(c) Local field  $\mathbf{B}$  **random** in **both magnitude and direction**:

All do not return to the same orientation at the same time  
(dephasing)  $\Rightarrow \mathbf{S}_\mu$  "relaxes" as  $G_{zz}(t)$  [Kubo & Toyabe, 1960's]

# Quantum Diffusion

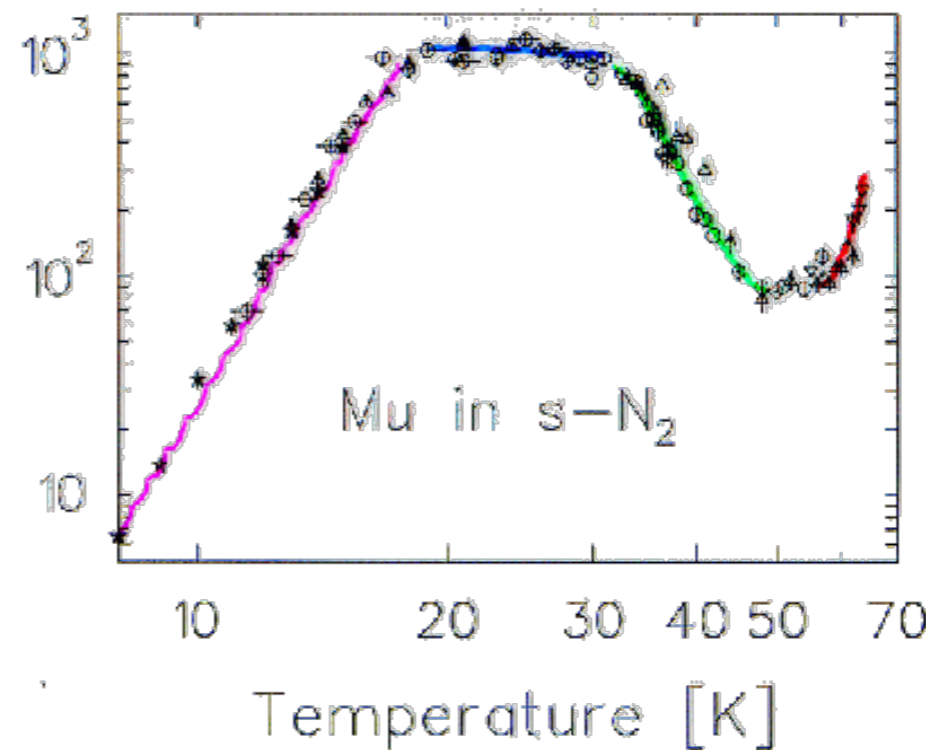
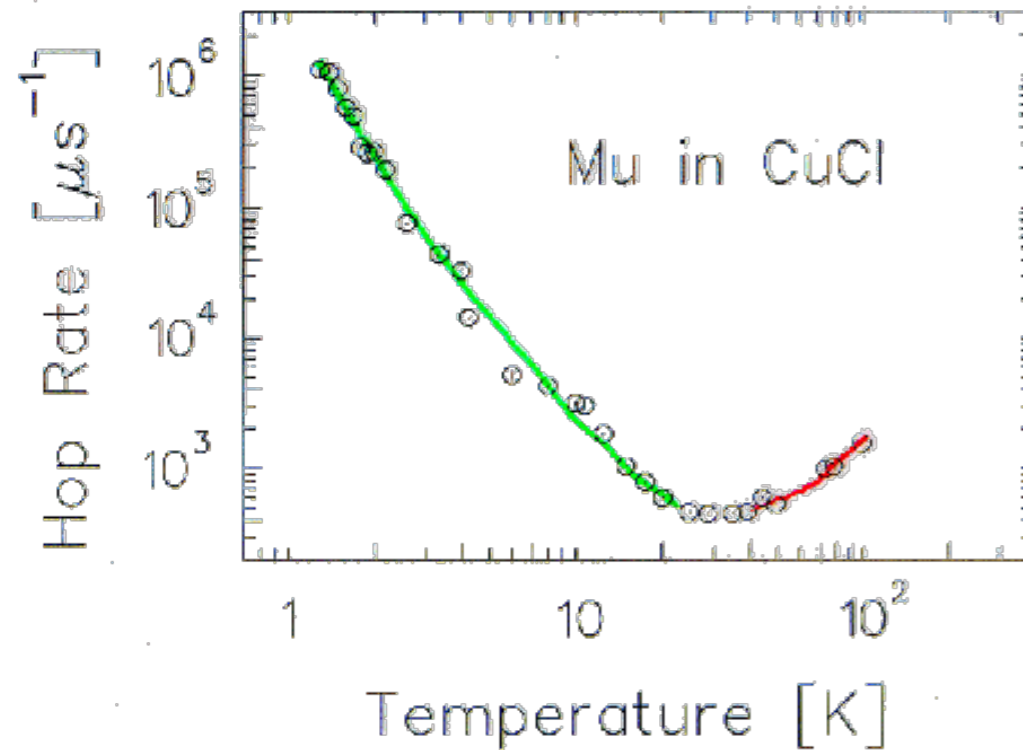
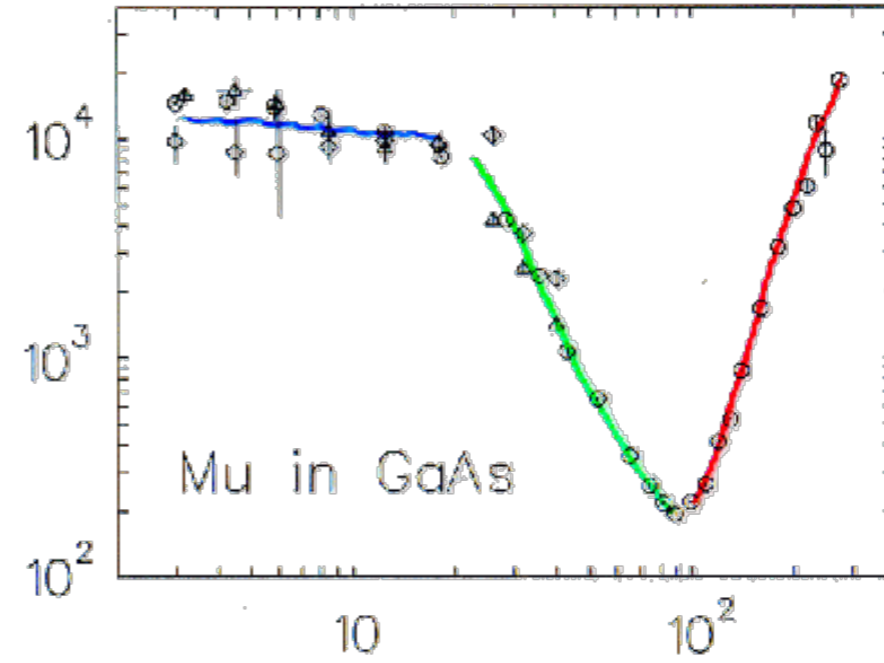
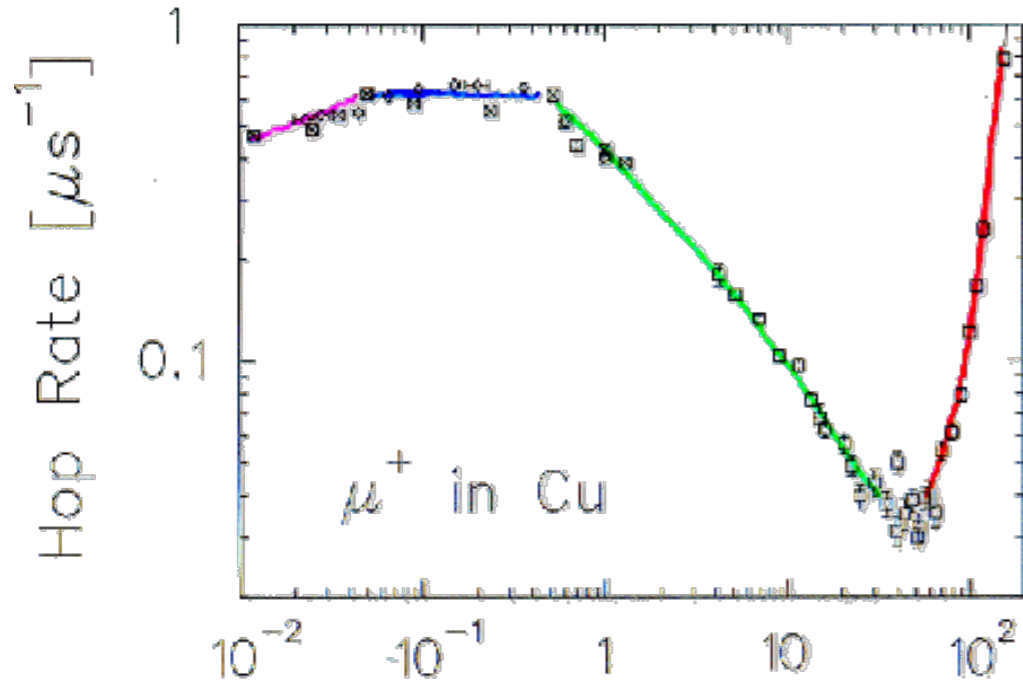

# Quantum Diffusion

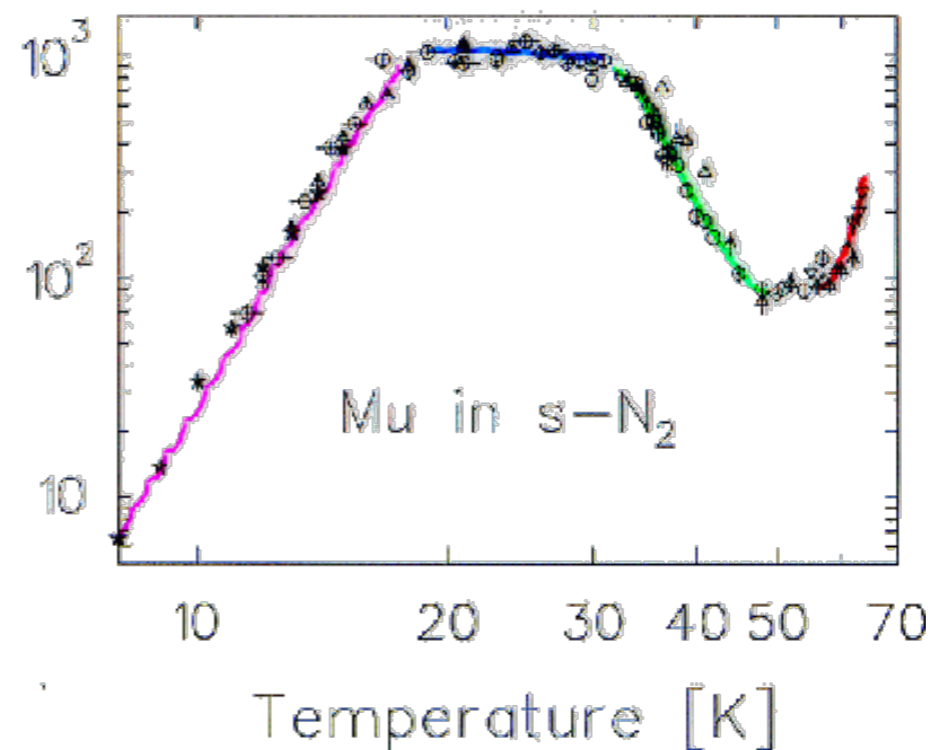
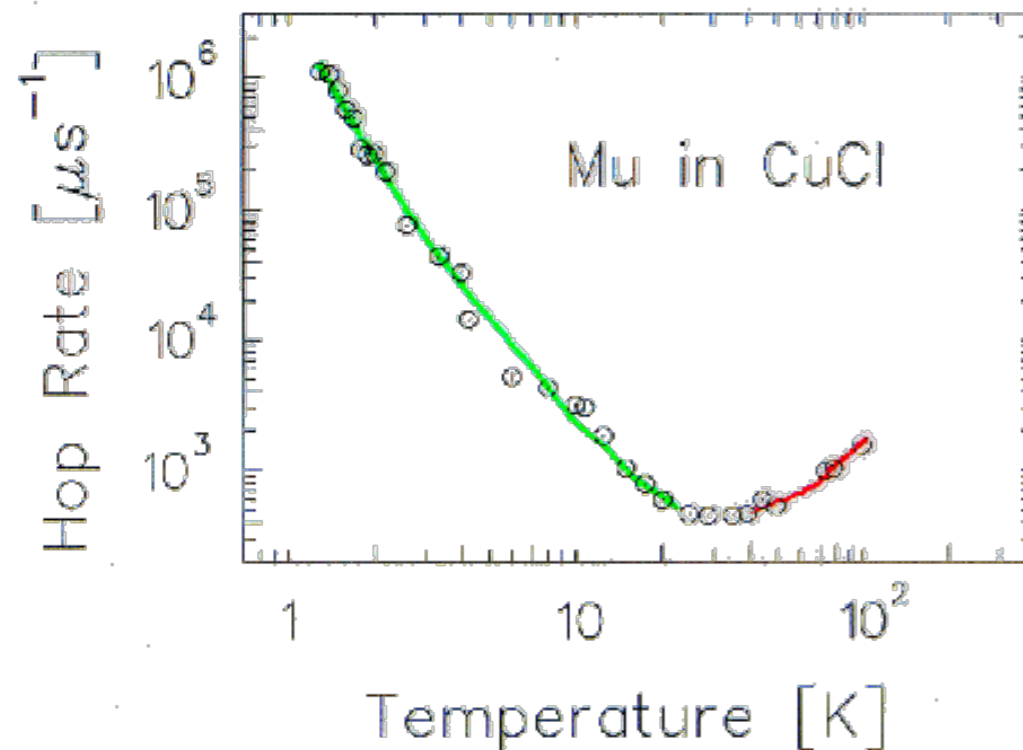
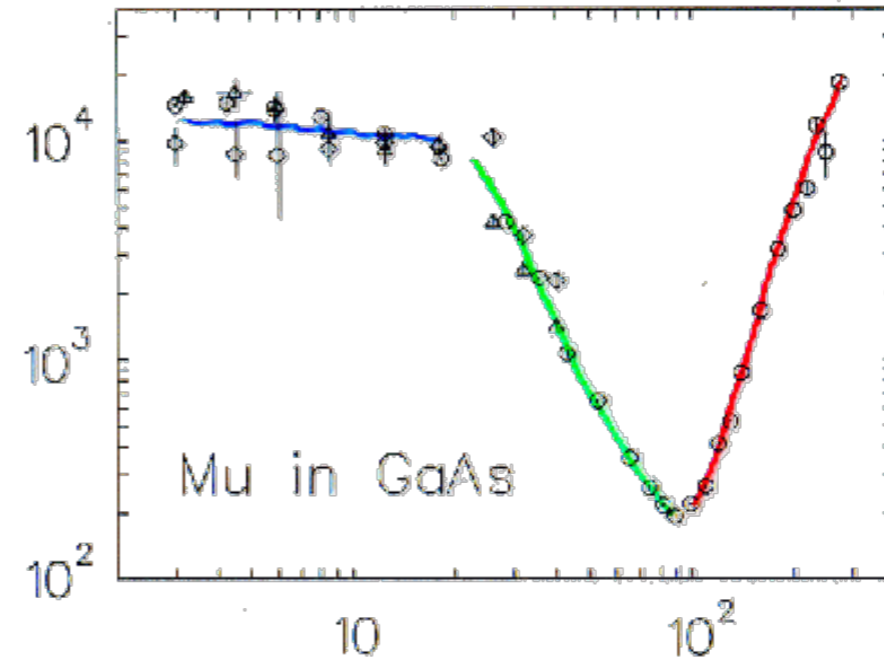
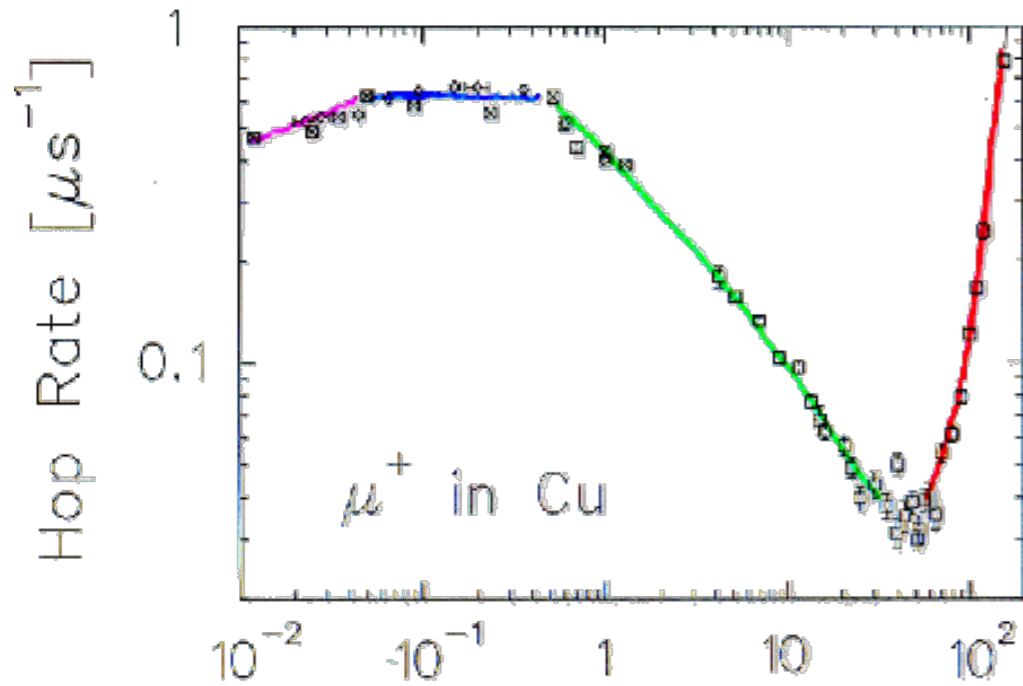

Thermally activated over-barrier *hopping* (incoherent).

↑ hot

Phonon scattering “spoils” coherent delocalization of *lattice polarons*.

↑ warm

Delocalized states find dilute defects and *trap*.

↓ cold



# Avoided Level-Crossing Resonance

## Nuclear Quadrupolar version: MnSi

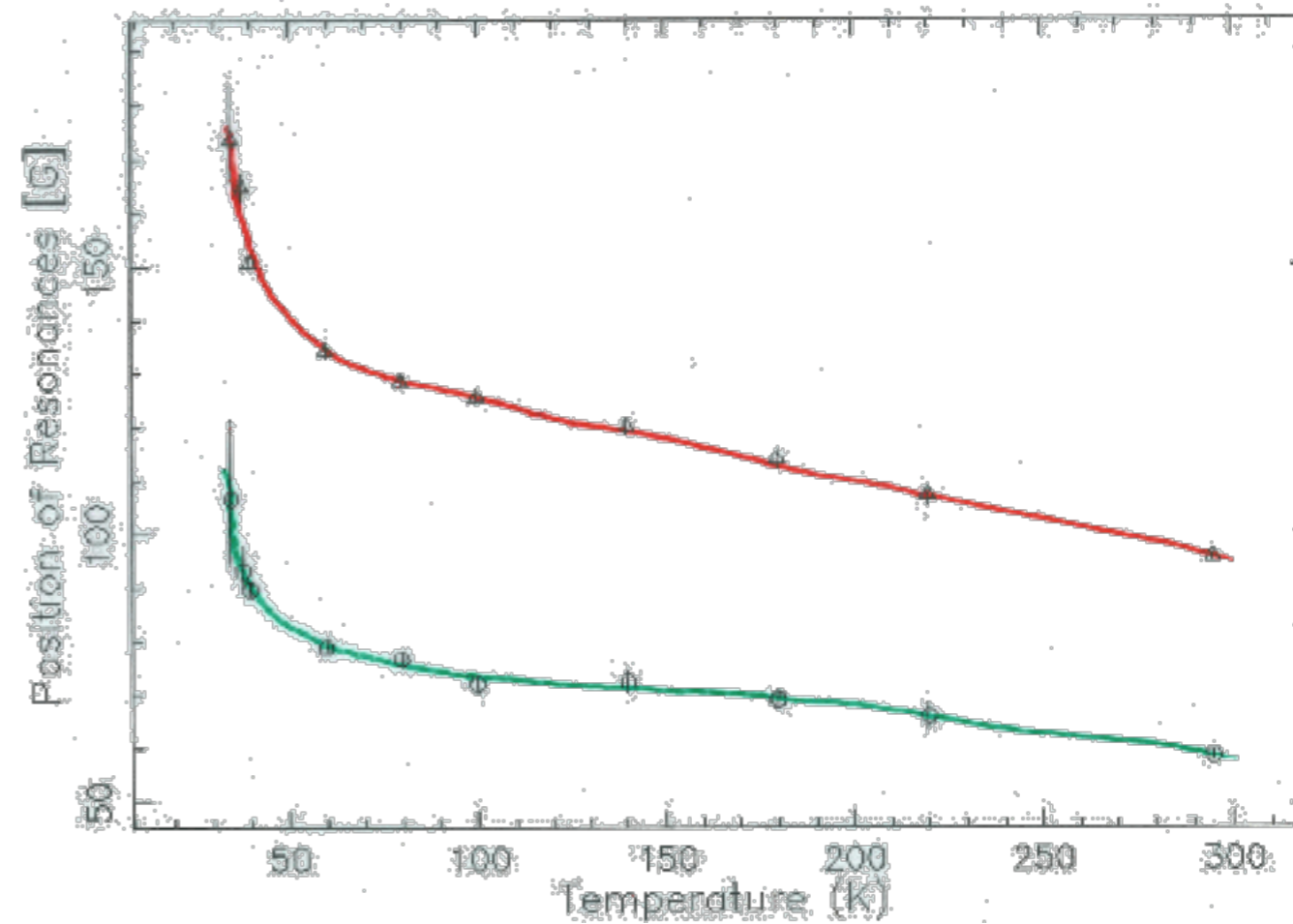
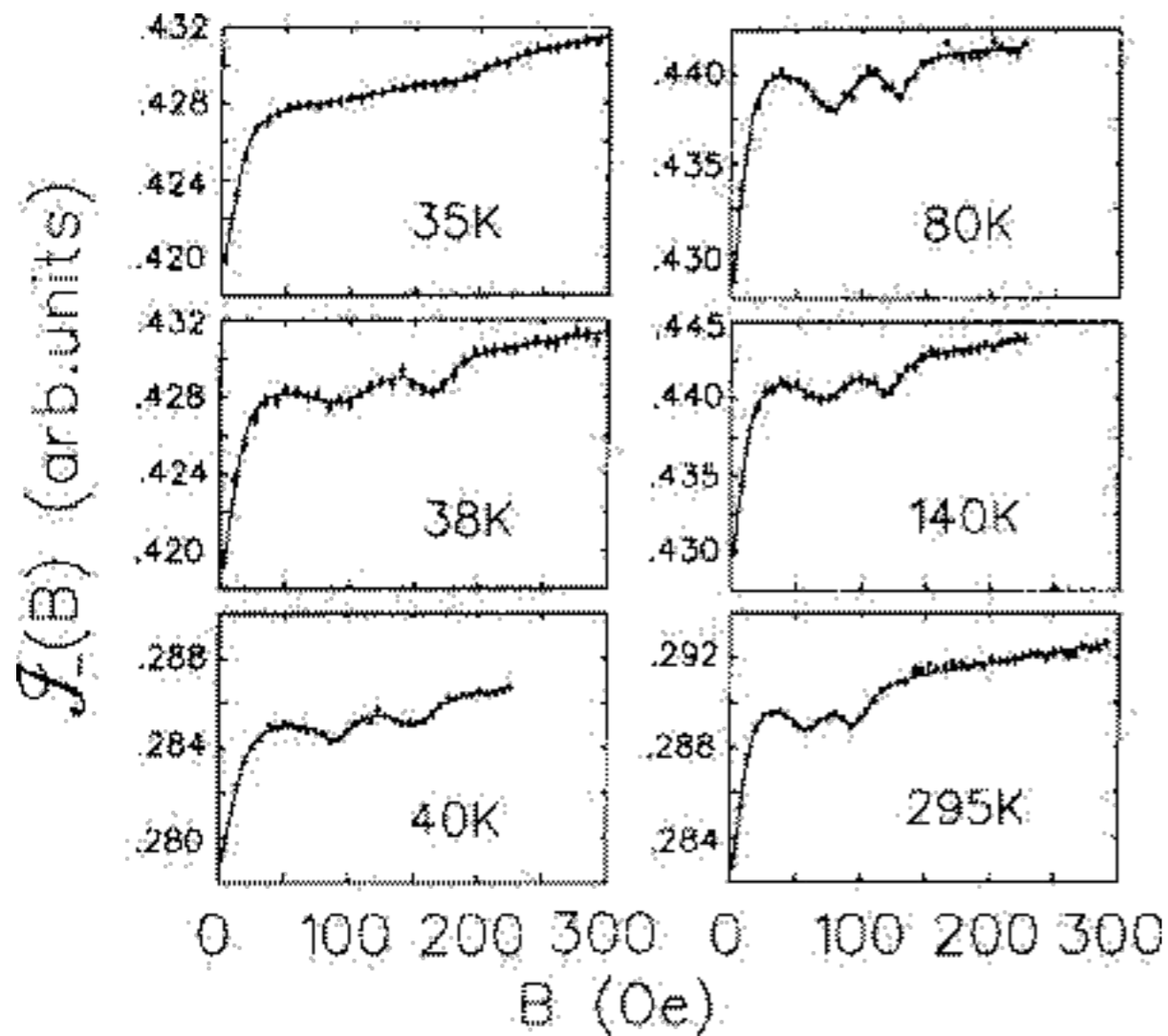

# Radiolysis & "Delayed" Muonium Formation

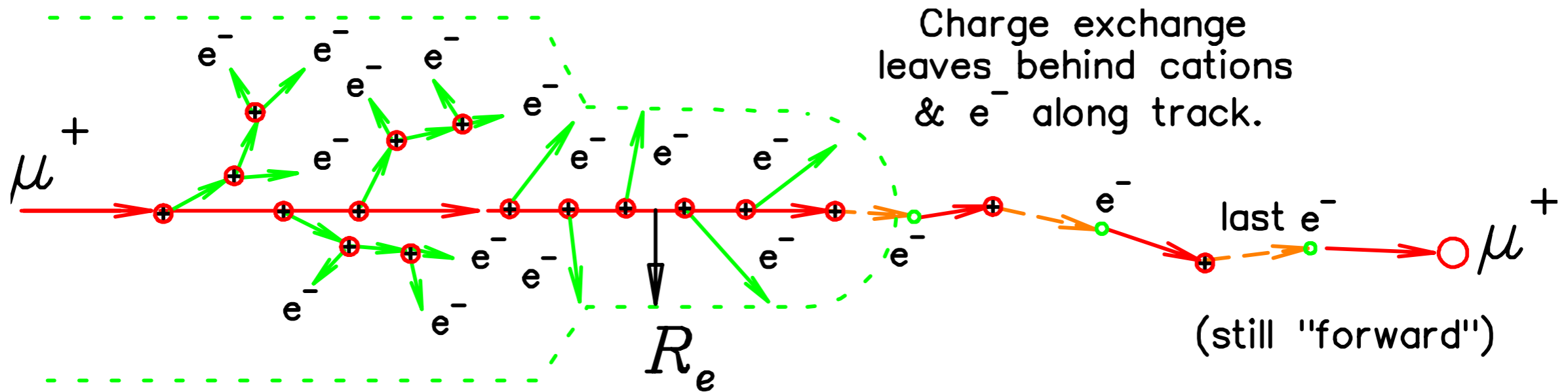

RESULT (sometimes):

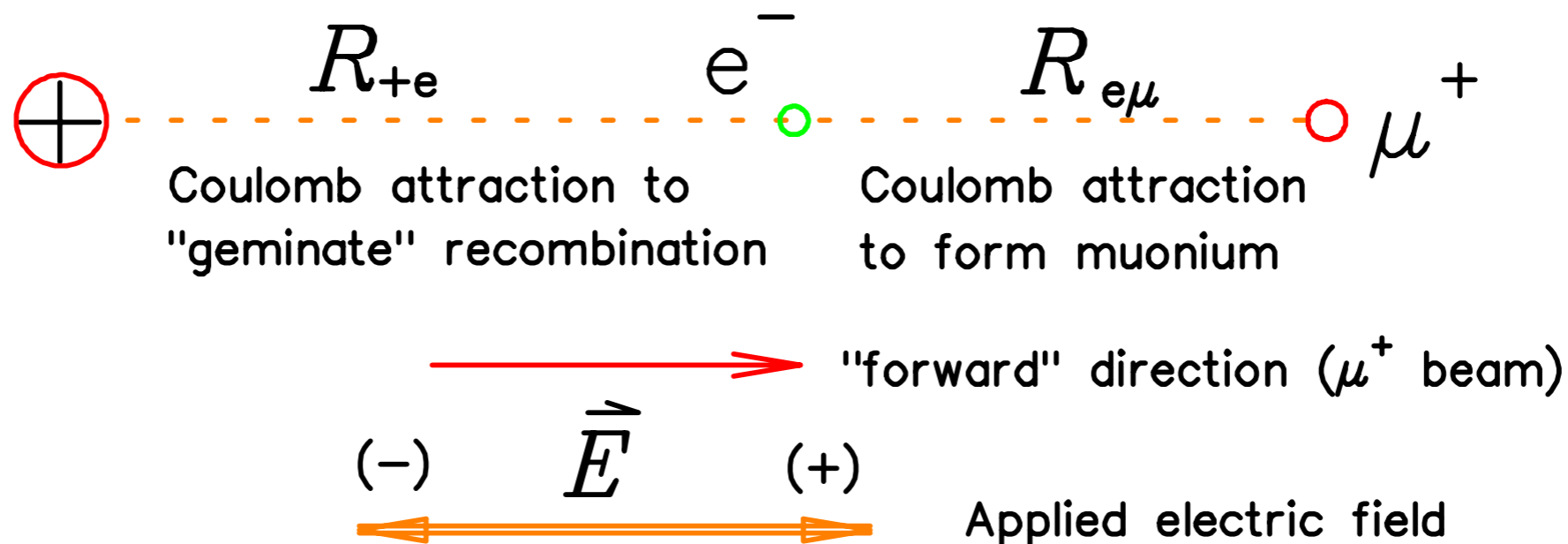

# Radiolysis & "Delayed" Muonium Formation

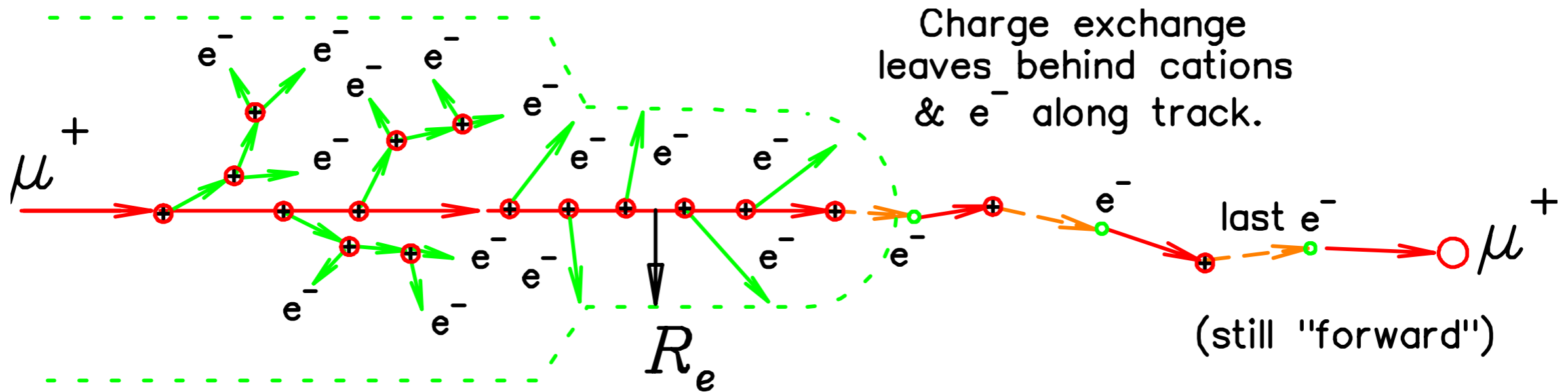

RESULT (sometimes):

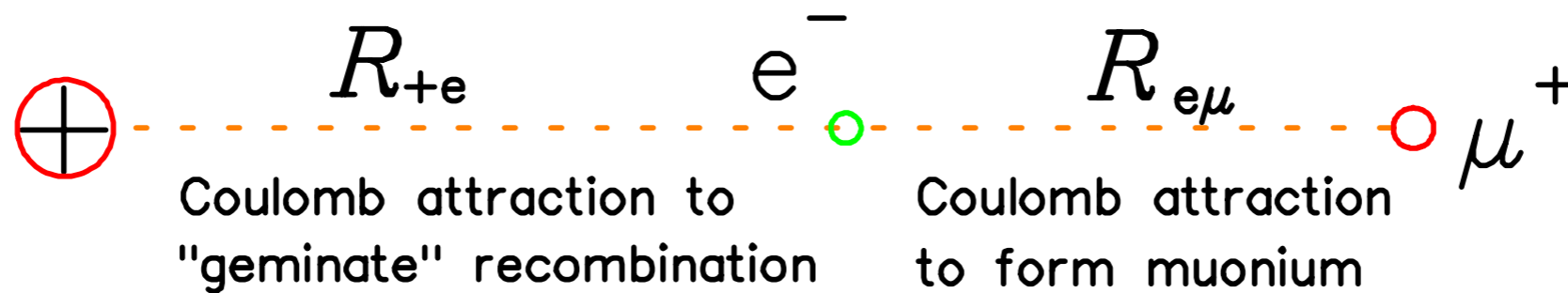

Possible exceptions:  
solids with extremely high electron mobilities.

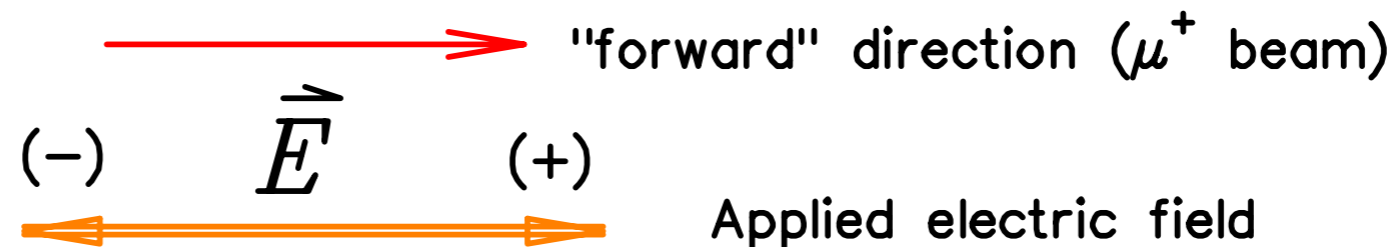

## A closer look at the **final charge exchange**:

(Actual path is probably less straight, but still "forward".)

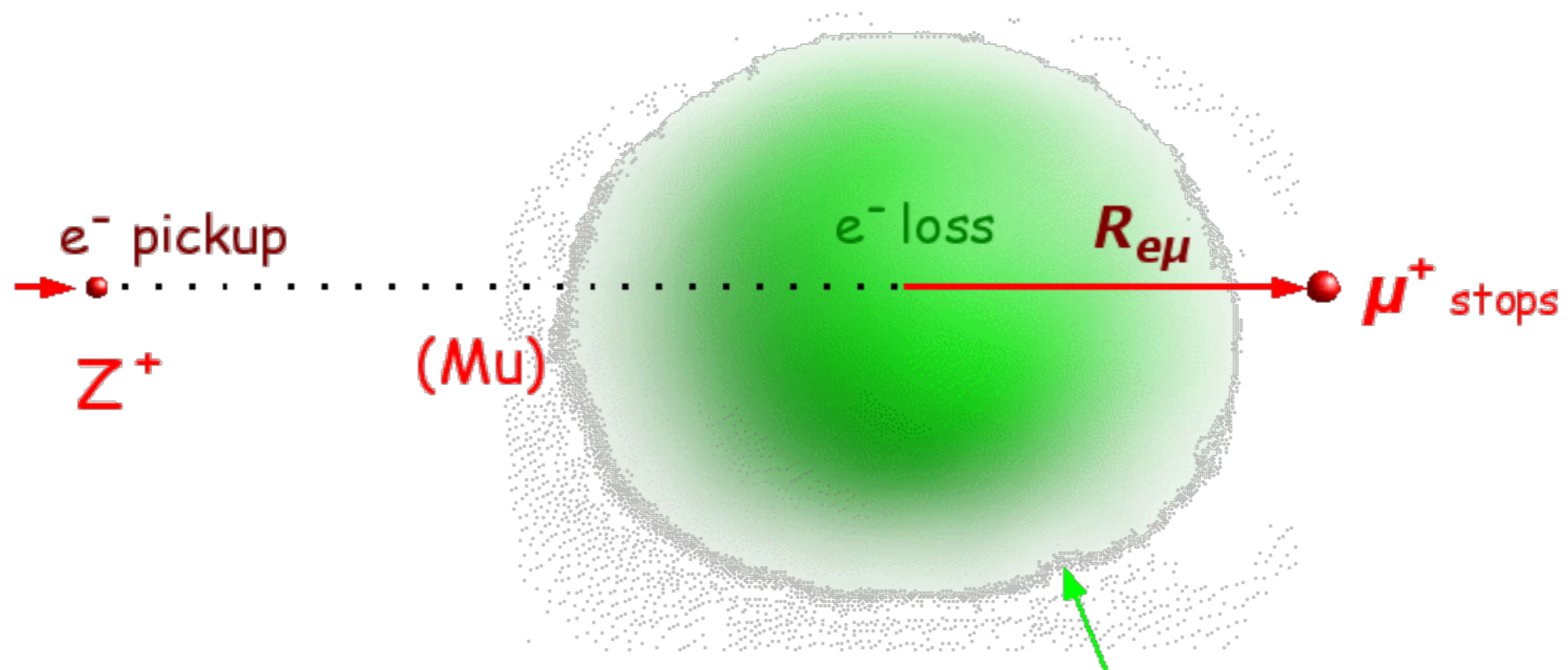

Distribution of "initial"  $e^-$  positions may overlap position where  $\mu^+$  stops

# Muonium Formation in an Electric Field

$\mu$ - $e$ - $E$  geometry:

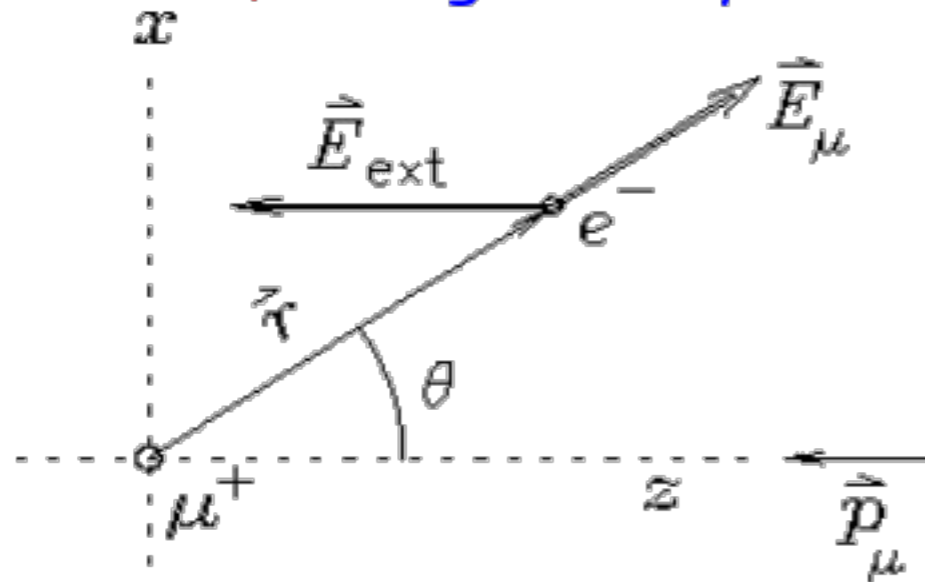

*Viscous flow model:*

$e^-$  constantly loses momentum to the medium, and so follows "lines of  $E$ " at constant speed.

Trajectories for  $E = 1$  kV/cm:

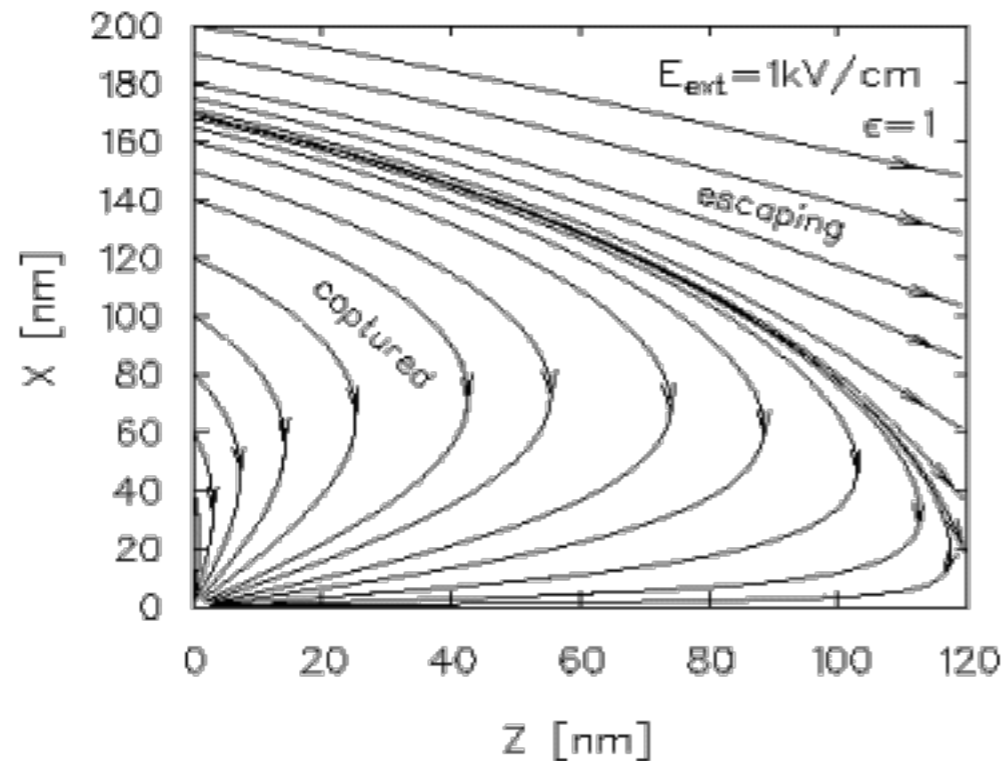

$e^-$  capture boundaries for  $E = 1/16$  to 16 kV/cm:

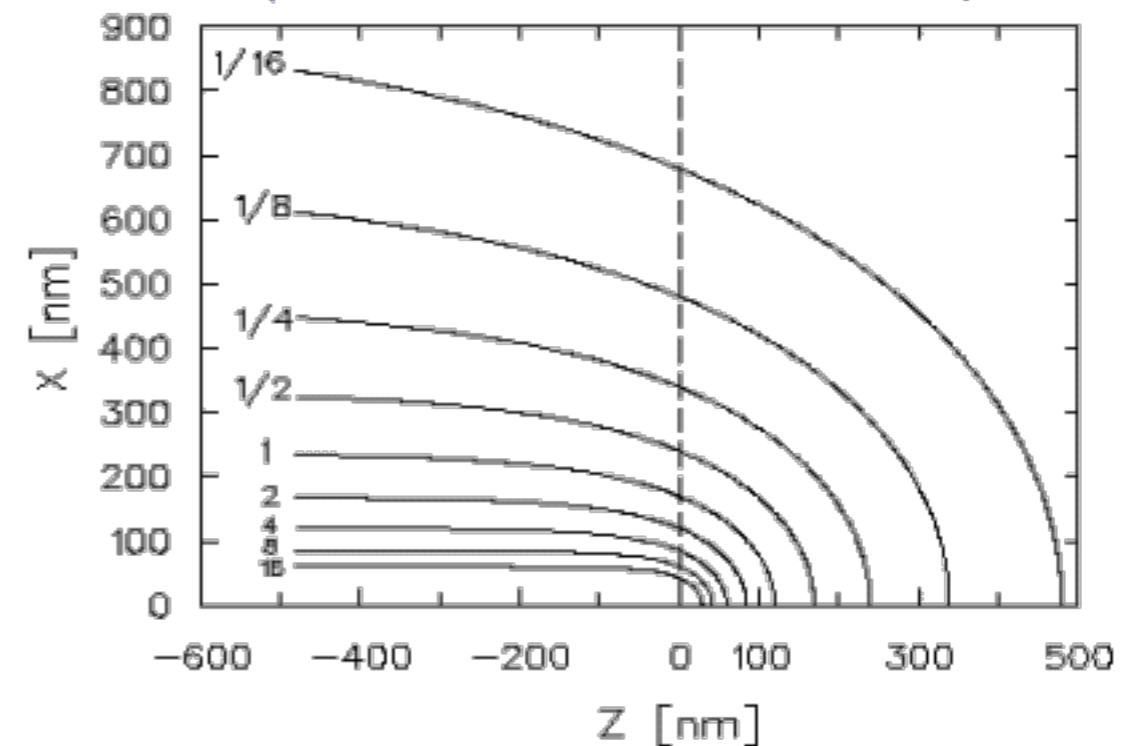

# Delayed Mu Formation in Cryocrystals (e.g. s-N<sub>2</sub>)

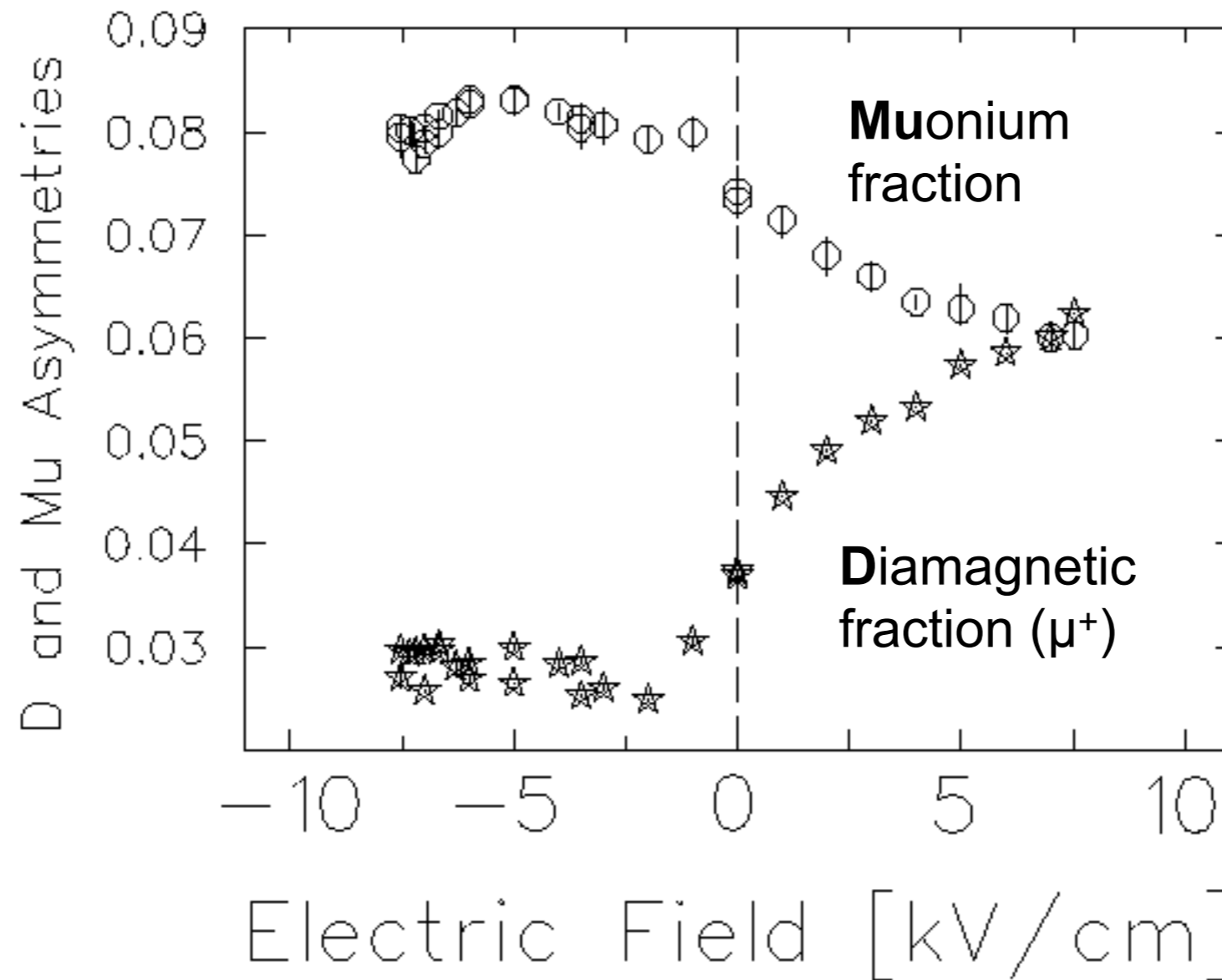

# "Ordinary" Solids: Insulators & Semiconductors

Note different horizontal & vertical scales!

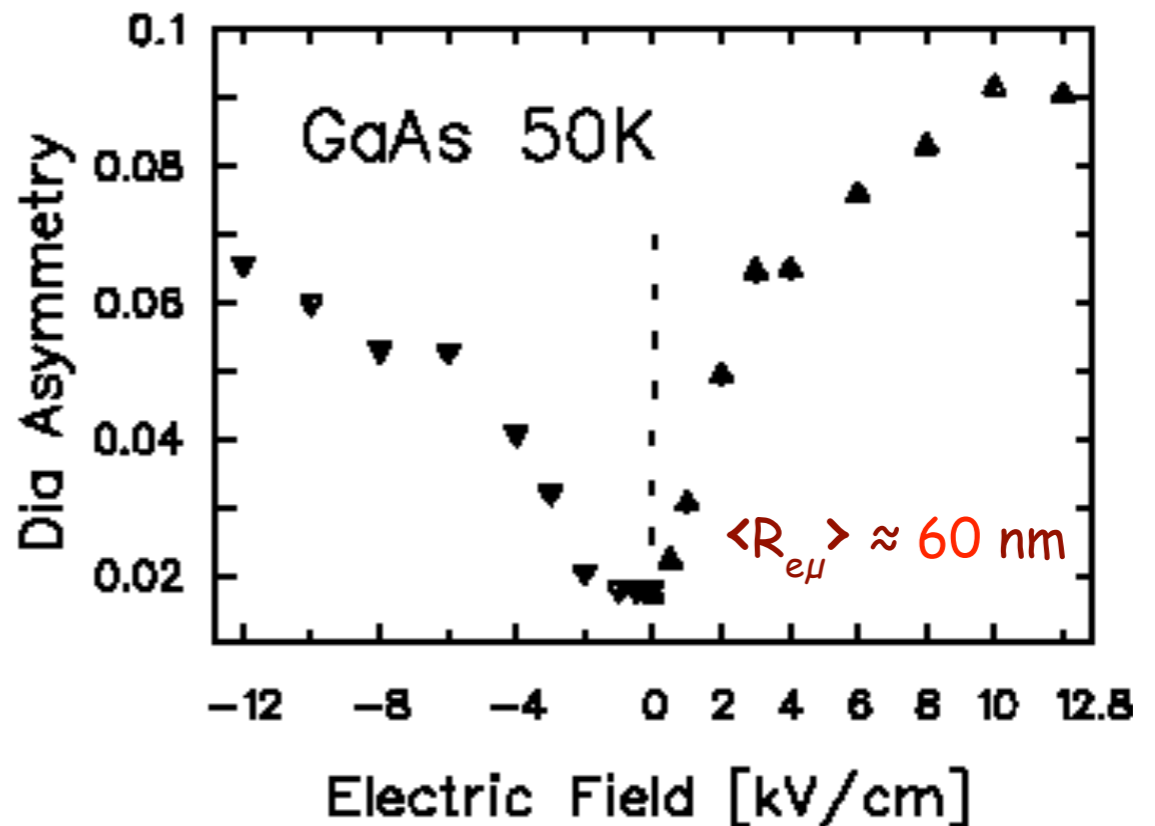
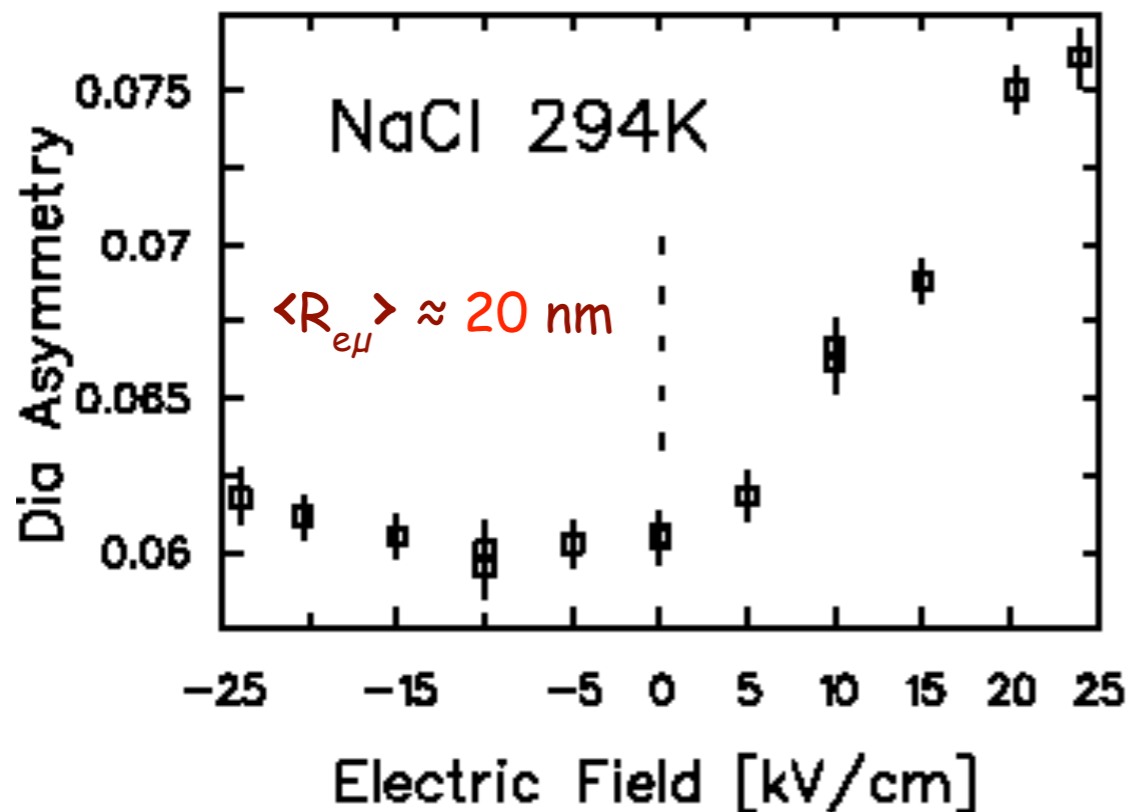
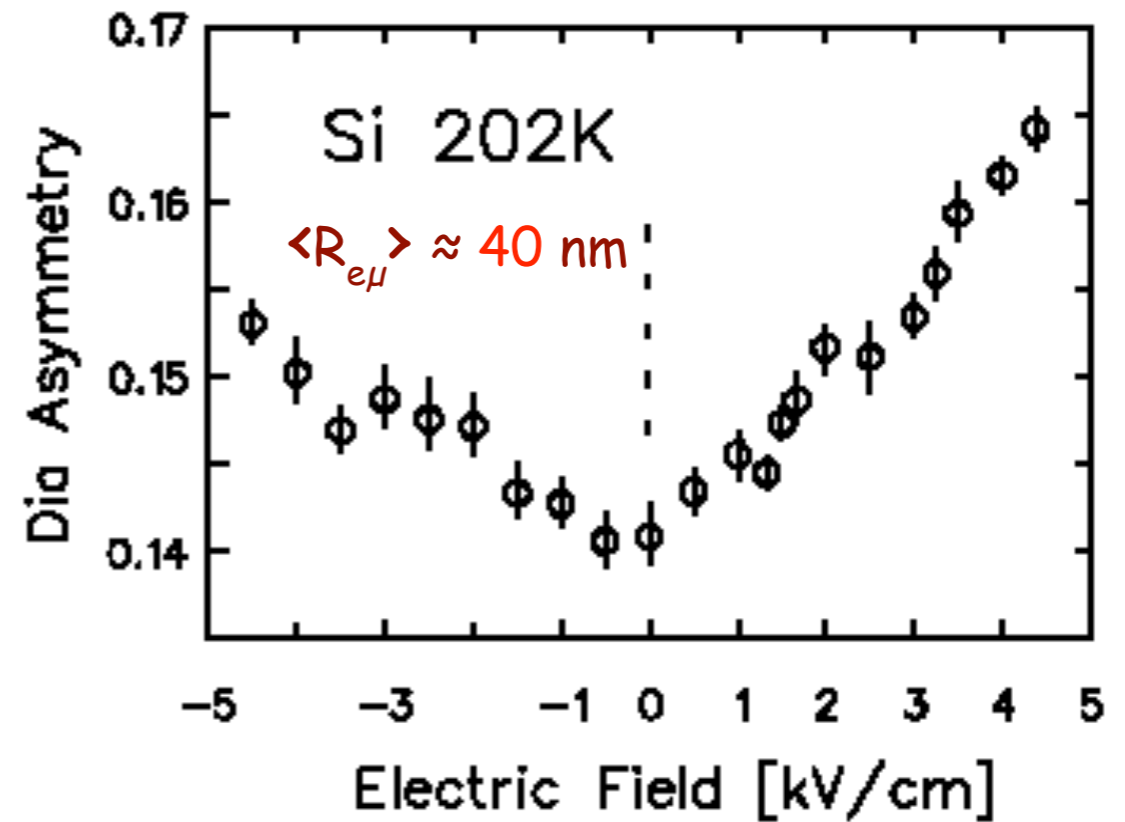
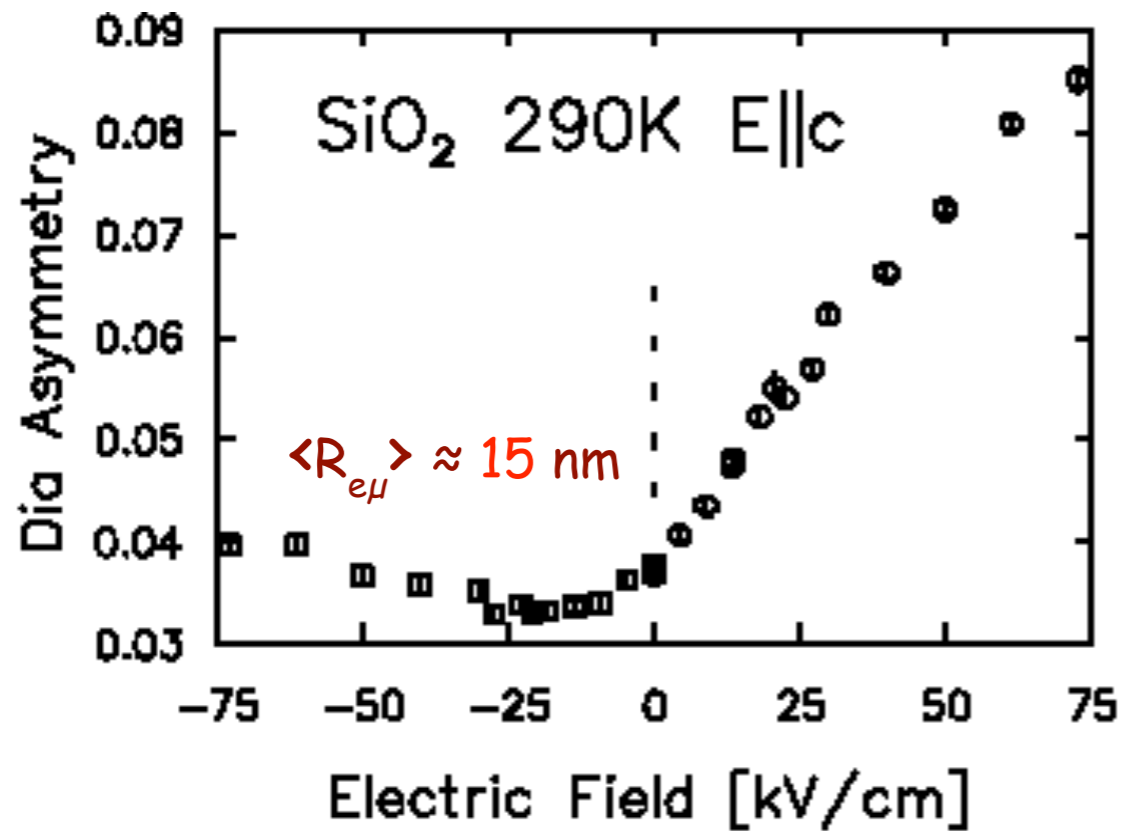

# Weakly Bound Mu States in High-Mobility Semiconductors

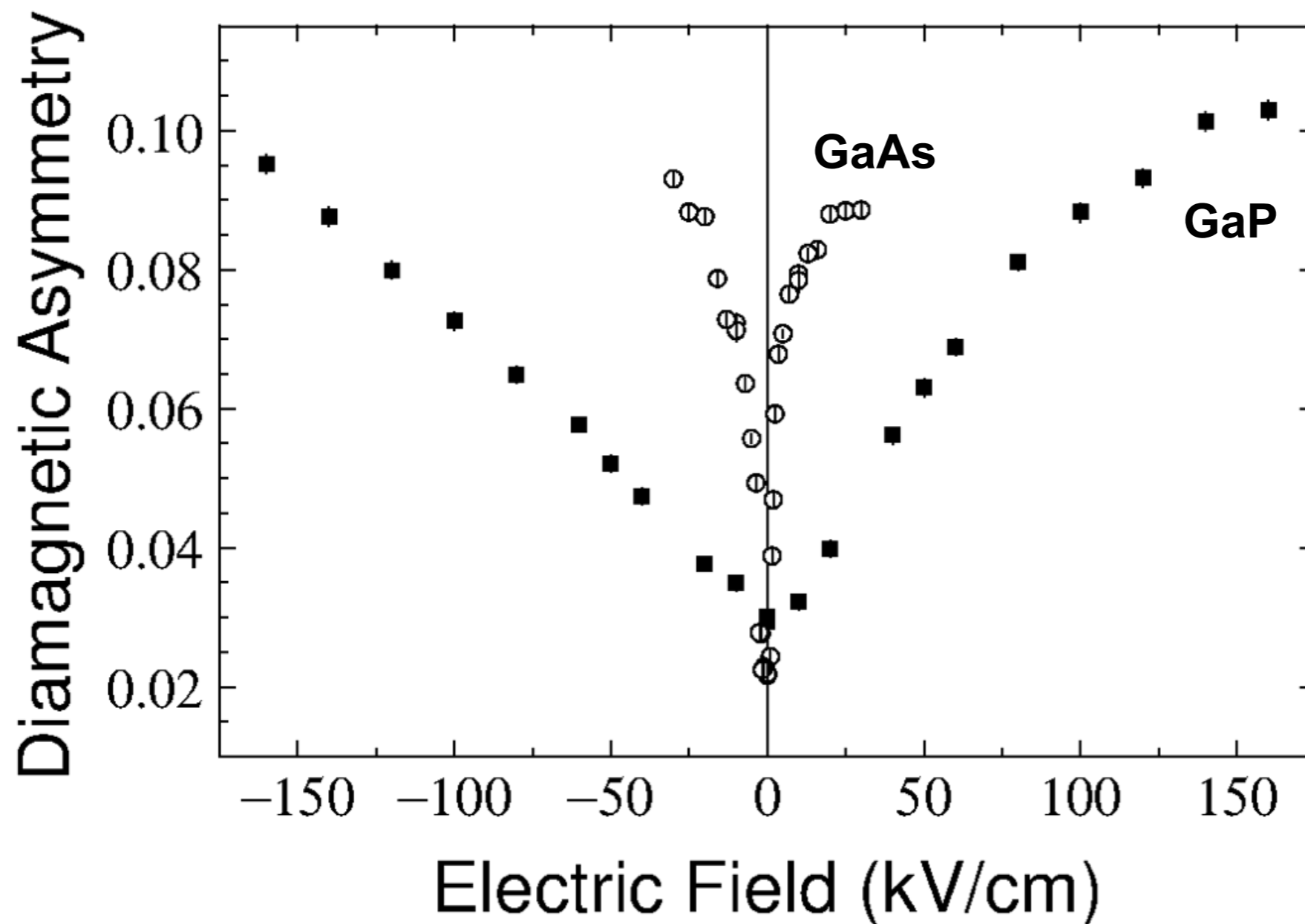

Initial states  $\text{Mu}_{\text{wb}}$  have electron orbitals “out in the lattice” with different effective masses; those with higher  $m^*$  are more strongly bound and harder to ionize with an applied  $\mathbf{E}$  field.

V.G. Storchak et al., Phys. Rev. B **67**, 121201 (2003).



# Weakly Bound Muonium States in GaAs & GaP

V.G. Storchak, D.G. Eshchenko, R.L. Lichti and J.H. Brewer

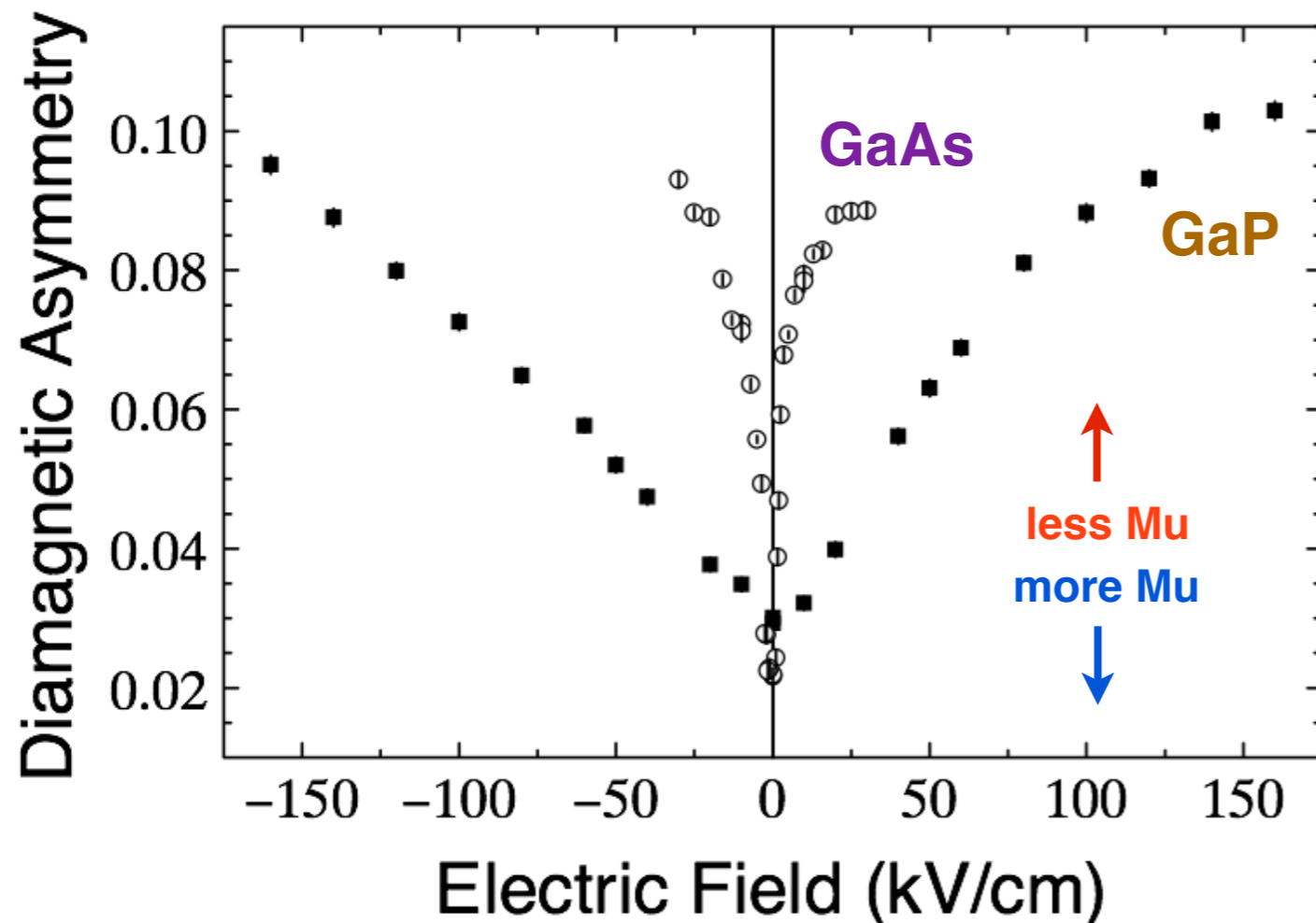

Muonium formation *via* electron transport to a positive muon implanted into semi-insulating GaP has been studied using muon spin rotation/relaxation with alternating electric fields up to 160 kV/cm. Formation of the muonium ground state is prohibited by a characteristic electric field of about 50 kV/cm in GaP compared to 5 kV/cm in GaAs, implying that formation of the Mu ground state may proceed through a weakly-bound intermediate state with a binding energy of about 23 meV in GaP or 7 meV in GaAs. These results are discussed and justified within the effective mass model.

See  $\mu$ SR Literature Entry # [2437](#)

[Phys. Rev. B \*\*67\*\*, 121201 \(2003\).](#)

# Weakly Bound Muonium States in GaAs & GaP

V.G. Storchak, D.G. Eshchenko, R.L. Lichti and J.H. Brewer

Lighter effective mass & higher mobility  $e^- \Rightarrow$   
easier to prevent Mu formation by applied  $E$ .

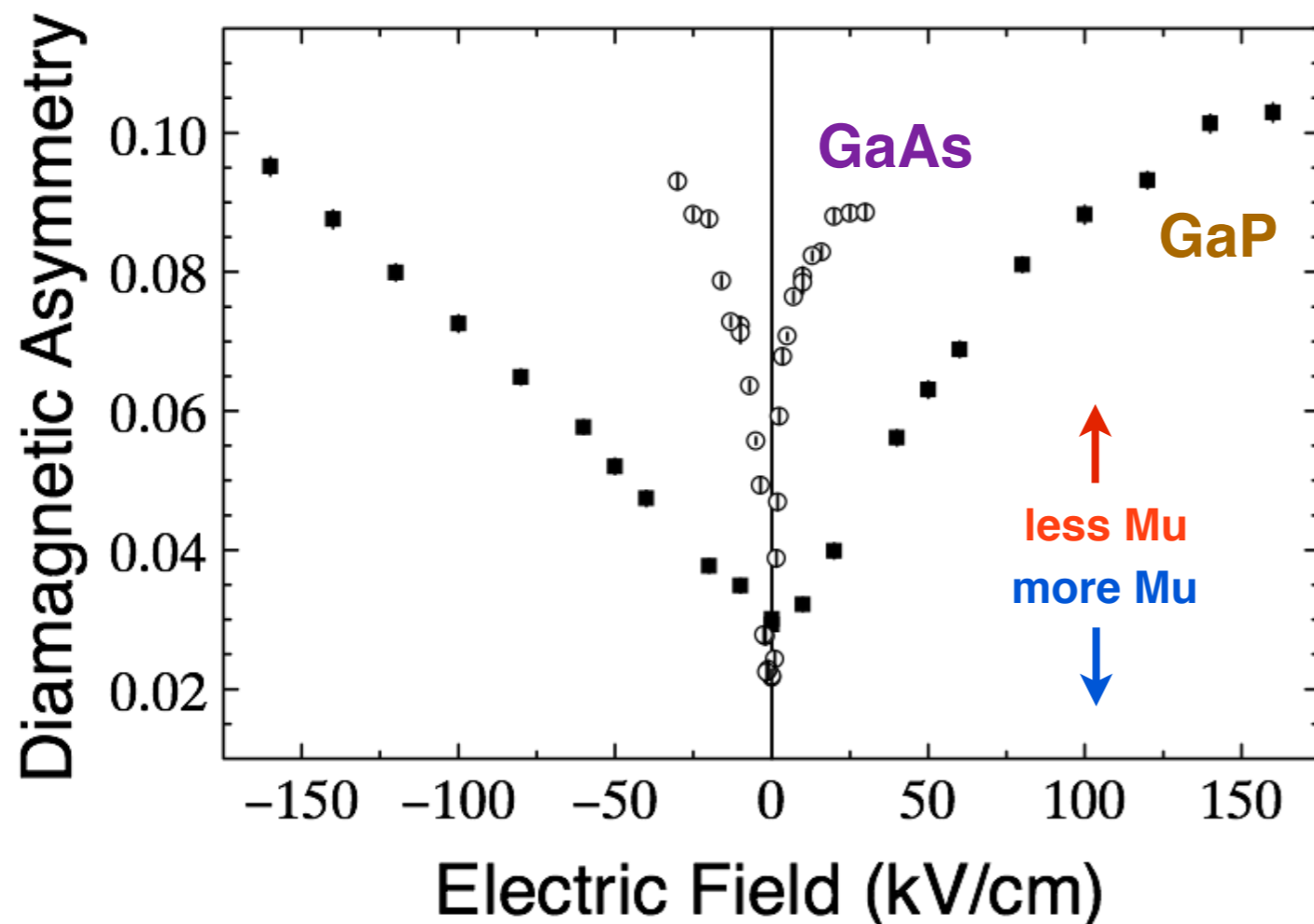

Muonium formation *via* electron transport to a positive muon implanted into semi-insulating GaP has been studied using muon spin rotation/relaxation with alternating electric fields up to 160 kV/cm. Formation of the muonium ground state is prohibited by a characteristic electric field of about 50 kV/cm in GaP compared to 5 kV/cm in GaAs, implying that formation of the Mu ground state may proceed through a weakly-bound intermediate state with a binding energy of about 23 meV in GaP or 7 meV in GaAs. These results are discussed and justified within the effective mass model.

See  $\mu$ SR Literature Entry # [2437](#)

[Phys. Rev. B 67, 121201 \(2003\).](#)